



URBAN
INNOVATIONS

URBAN EQUIPMENT 026 - 027





Η εταιρεία δημιουργήθηκε το 1975, με την επωνυμία Χυτήρια - μηχανουργία Τσίντζα και σήμερα, ως Urban Innovations πλέον, είναι κορυφαία εταιρεία κατασκευής προϊόντων αστικού εξοπλισμού στην Ελλάδα διαθέτοντας τεχνογνωσία υψηλής, ποιότητας υλικά αλλά και εξειδικευμένο προσωπικό.

Με στόχο την καινοτομία και την ποιότητα, η Urban Innovations συνεχίζει να συμβάλλει στην ανάπτυξη και την αναβάθμιση του αστικού περιβάλλοντος.

Urban Innovations was founded in 1975. Over the years became a leading manufacturer of urban equipment products in Greece, with know-how, high quality materials and specialized personnel.

Aiming at innovation and quality, Urban Innovations continues to contribute to the development and upgrading of the urban environment.

ΠΙΣΤΟΠΟΙΗΣΕΙΣ - CERTIFICATES



ISO 9001: 2015

ΠΙΣΤΟΠΟΙΗΤΙΚΟ ΔΙΑΣΦΑΛΙΣΗΣ ΠΟΙΟΤΗΤΑΣ



ISO 14001: 2015

ΠΕΡΙΒΑΛΛΟΝΤΙΚΗΣ ΔΙΑΧΕΙΡΙΣΗΣ



ISO 26000: 2010

ΣΥΣΤΗΜΑ ΔΙΑΧΕΙΡΙΣΗΣ
ΕΤΑΙΡΙΚΗΣ ΚΟΙΝΩΝΙΚΗΣ ΕΥΘΥΝΗΣ



ISO 37001: 2016

ΣΥΣΤΗΜΑΤΑ ΔΙΑΧΕΙΡΙΣΗΣ
ΚΑΤΑ ΤΗΣ ΔΩΡΟΔΟΚΙΑΣ



ISO 45001: 2018

ΔΙΑΧΕΙΡΙΣΗ ΤΗΣ ΥΓΕΙΑΣ
ΚΑΙ ΤΗΣ ΑΣΦΑΛΕΙΑΣ ΣΤΗΝ ΕΡΓΑΣΙΑ



ISO 27001

ΔΙΑΧΕΙΡΙΣΗ ΤΗΣ ΑΣΦΑΛΕΙΑΣ
ΤΩΝ ΠΛΗΡΟΦΟΡΙΩΝ



The mark of
responsible forestry
FSC® A000504

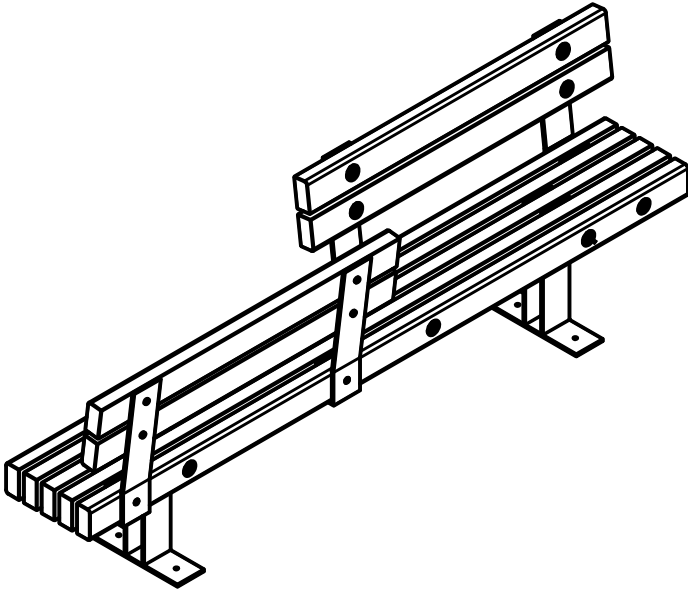

Γενικές Διαστάσεις General Dimensions	A	B	H
	2700	500	905

*διαστάσεις σε mm *dimensions in mm

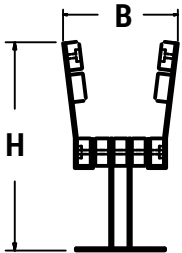
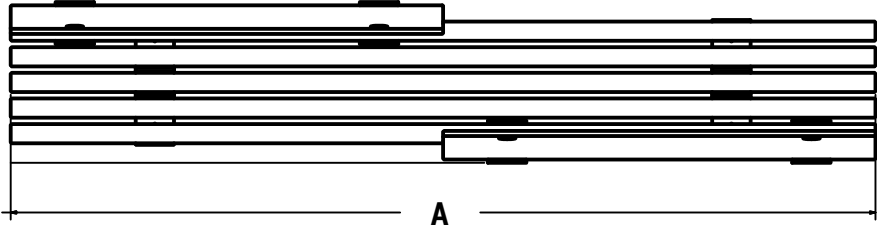

Κωδικός Προϊόντος | Product Code: S154 -3



Γενικές Διαστάσεις
General Dimensions

A	B1	B2	H1	H2
2700	2230	380	490	640

*διαστάσεις σε mm *dimensions in mm

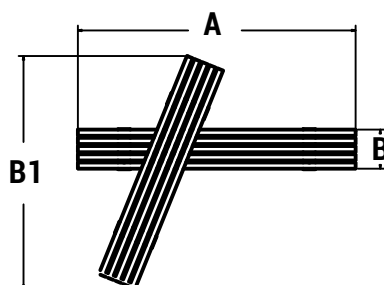
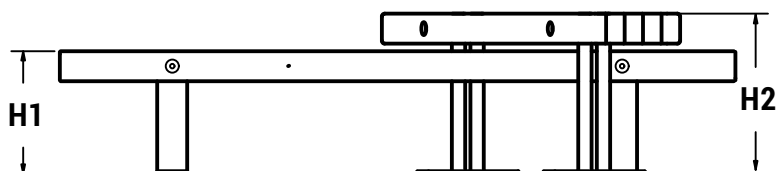
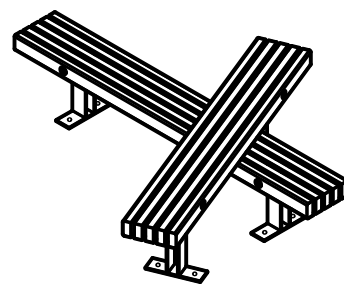

Κωδικός Προϊόντος | Product Code: S154



Κωδικός Προϊόντος | Product Code: S154 -1

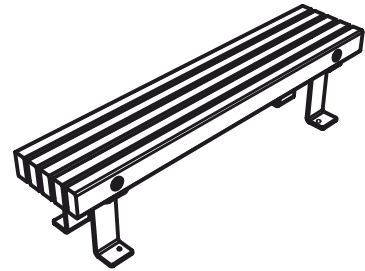
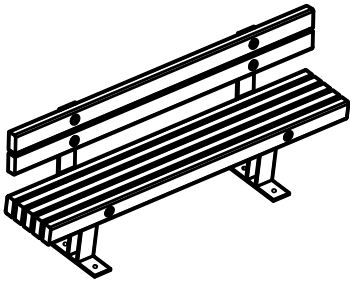
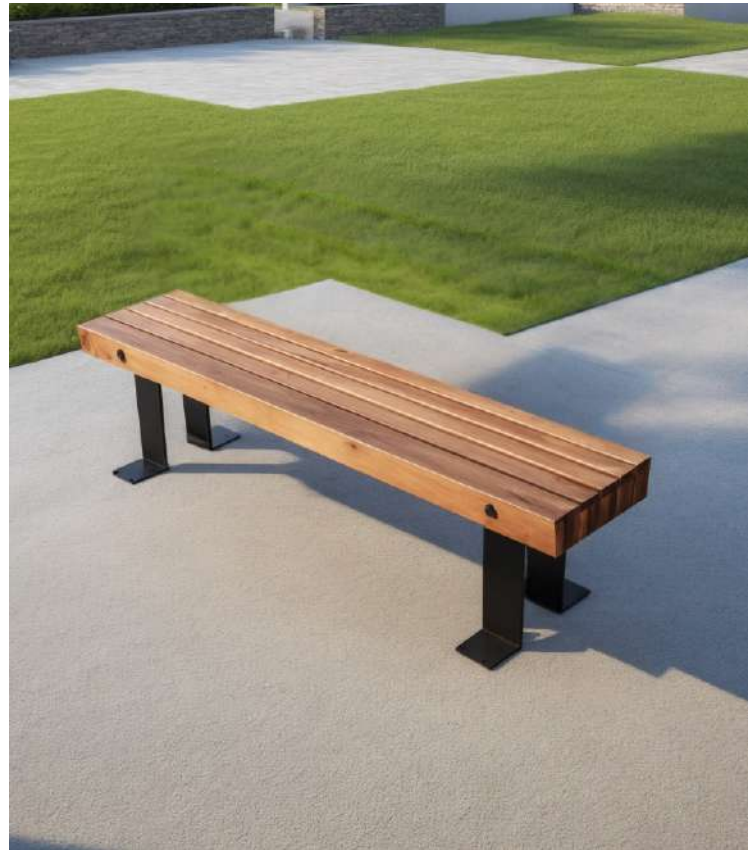

Γενικές Διαστάσεις
General Dimensions

A	B	H
1800	490	910

Γενικές Διαστάσεις
General Dimensions

A	B	H
1500 - 2000	400	450

*διαστάσεις σε mm *dimensions in mm

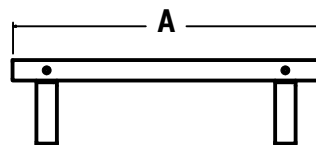
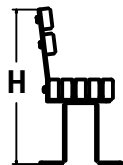
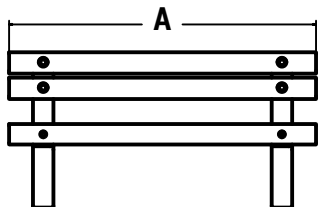

Κωδικός Προϊόντος | Product Code: S154 -4



Γενικές Διαστάσεις
General Dimensions

A	B	H
2000	440	910

*διαστάσεις σε mm *dimensions in mm

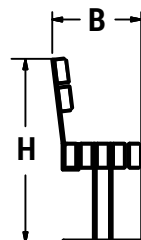
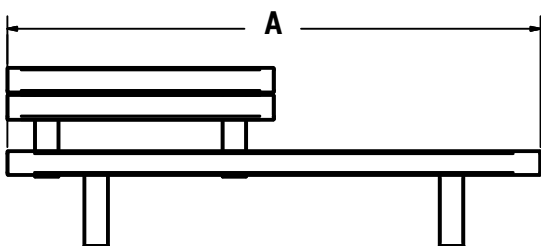
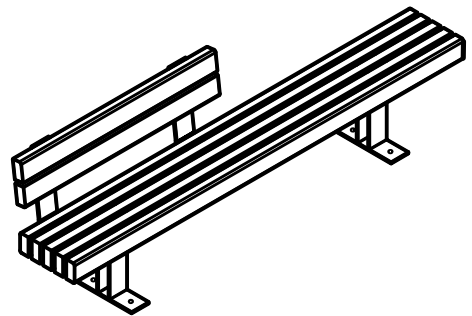

Κωδικός Προϊόντος | Product Code: S164



Γενικές Διαστάσεις
General Dimensions

A	B	H
1800	850	870

*διαστάσεις σε mm *dimensions in mm

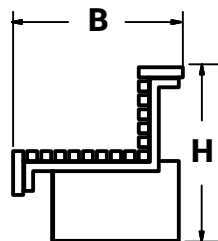
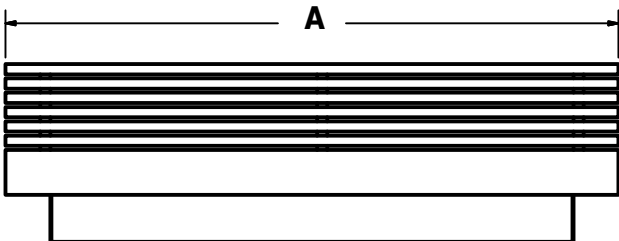
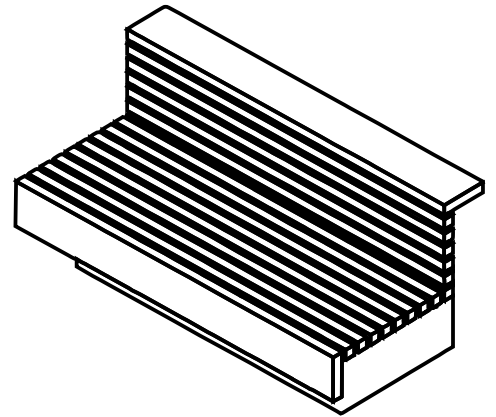

Κωδικός Προϊόντος | Product Code: S92



Γενικές Διαστάσεις
General Dimensions

A	B	H
3000	800	450

*διαστάσεις σε mm *dimensions in mm

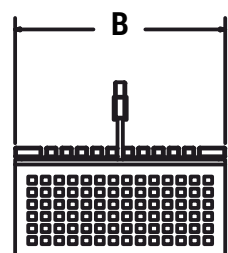
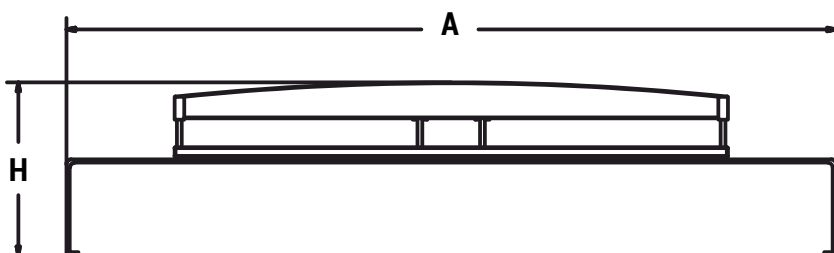
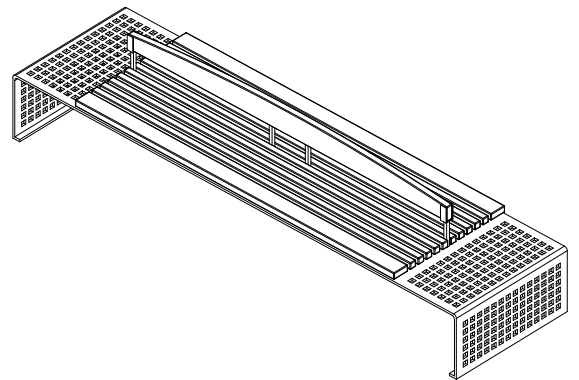

Κωδικός Προϊόντος | Product Code: S217



Γενικές Διαστάσεις
General Dimensions

A	B	H	H1
4500	830	930	490

*διαστάσεις σε mm *dimensions in mm

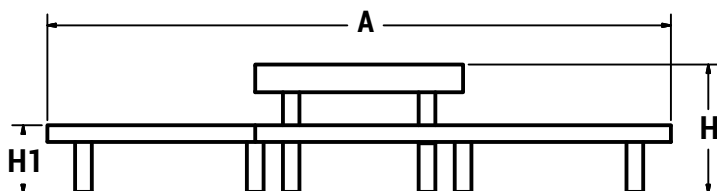
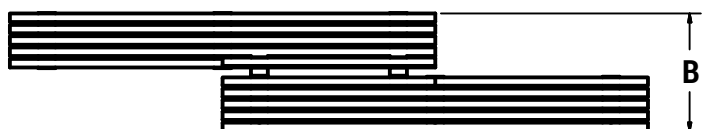
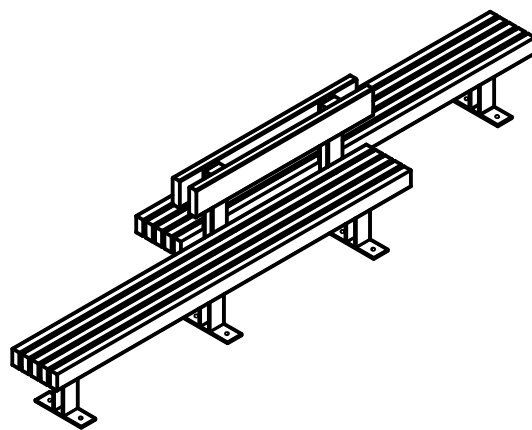

Κωδικός Προϊόντος | Product Code: S159



Γενικές Διαστάσεις
General Dimensions

A	B	H
2500	620	840

*διαστάσεις σε mm *dimensions in mm

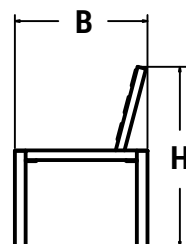
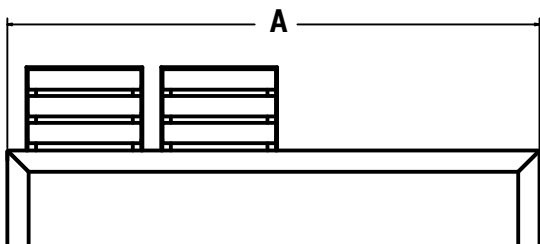
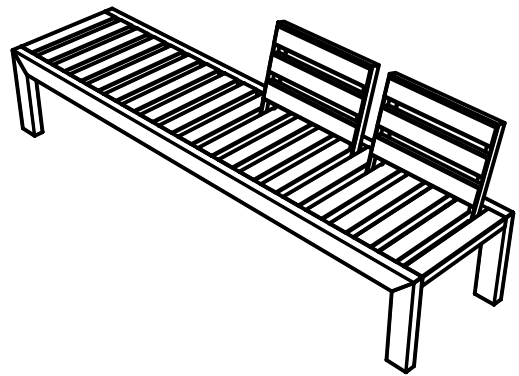

Κωδικός Προϊόντος | Product Code: S283



Γενικές Διαστάσεις
General Dimensions

A	B	H
1800	660	780

*διαστάσεις σε mm *dimensions in mm

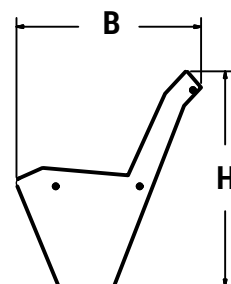
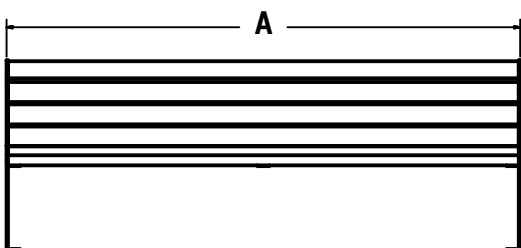
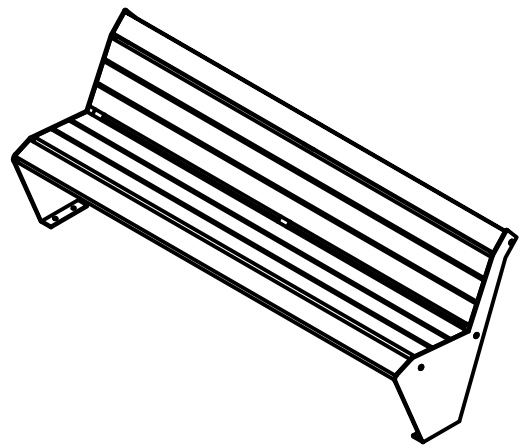

Κωδικός Προϊόντος | Product Code: S132

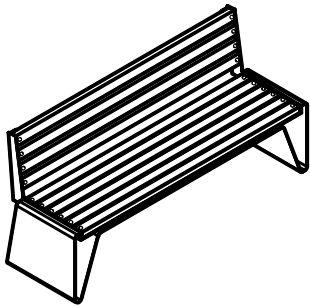

Γενικές Διαστάσεις
General Dimensions

A	B	H
1800	560	840

*διαστάσεις σε mm *dimensions in mm

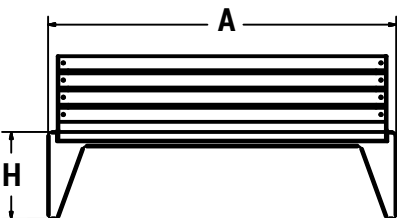
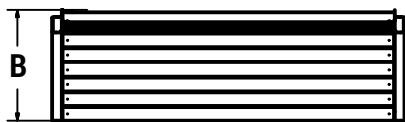

Κωδικός Προϊόντος | Product Code: S132 - 1

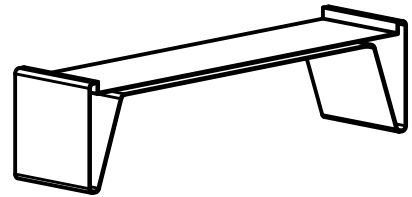

Γενικές Διαστάσεις
General Dimensions

A	B	H
1800	420	450

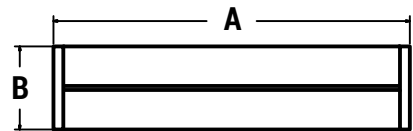

Κωδικός Προϊόντος | Product Code: S329



Γενικές Διαστάσεις
General Dimensions

A	B	H
1700	500	840

*διαστάσεις σε mm *dimensions in mm

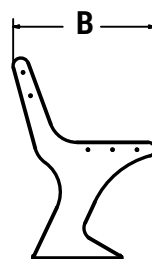
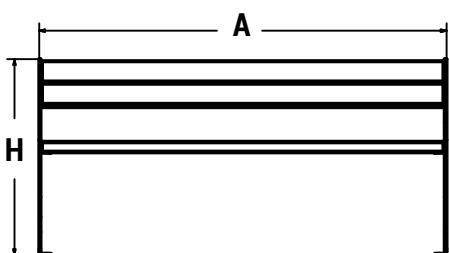
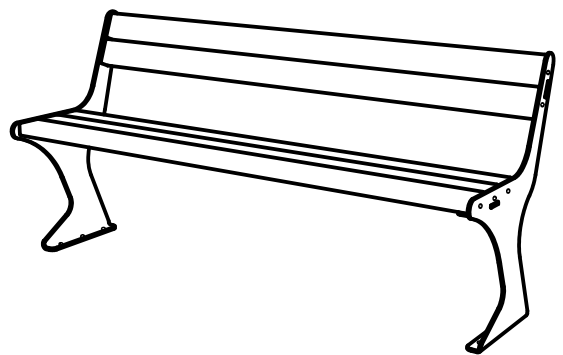

Κωδικός Προϊόντος | Product Code: S224



Γενικές Διαστάσεις
General Dimensions

A	B	H
1800	620	810

*διαστάσεις σε mm *dimensions in mm

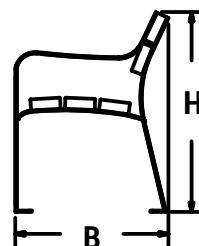
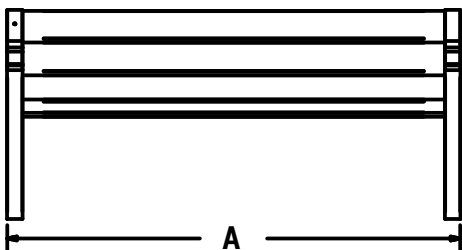
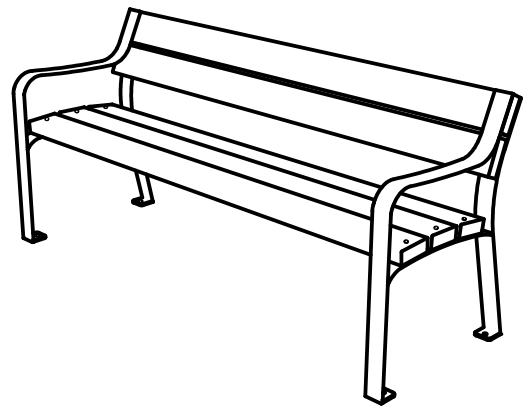

Κωδικός Προϊόντος | Product Code: S117



Γενικές Διαστάσεις
General Dimensions

A	B	H	H1
1800	490	450	850

*διαστάσεις σε mm *dimensions in mm

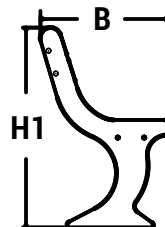
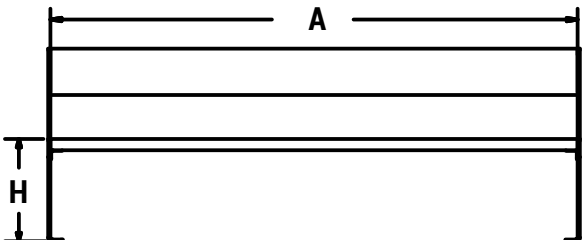
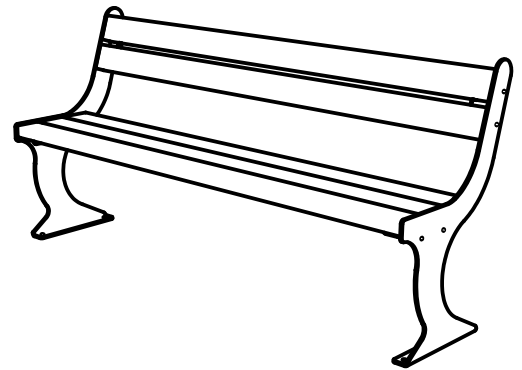

Κωδικός Προϊόντος | Product Code: S339



Γενικές Διαστάσεις
General Dimensions

A	B	H
1300	1100	400

*διαστάσεις σε mm *dimensions in mm

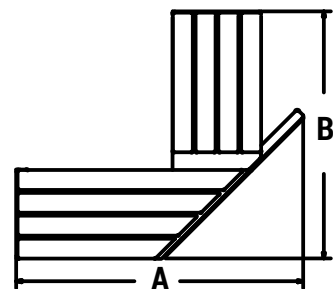
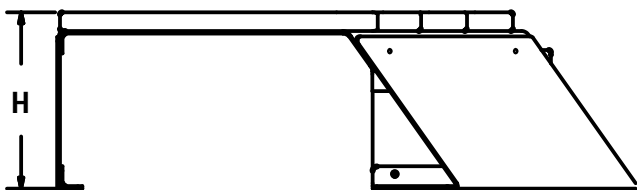
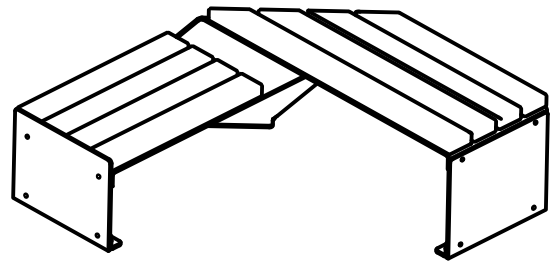

Κωδικός Προϊόντος | Product Code: S135



Γενικές Διαστάσεις General Dimensions	A	B	H
	1500 -2000	520	860

*διαστάσεις σε mm *dimensions in mm

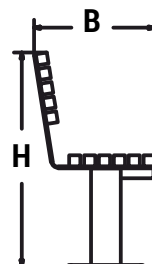
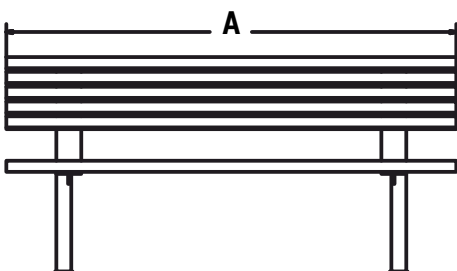
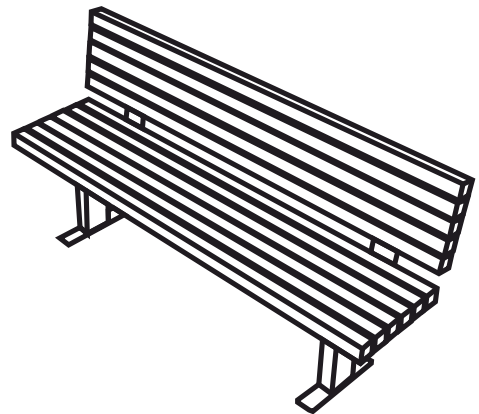

Κωδικός Προϊόντος | Product Code: S138 - Μαντέμι Cast iron



Γενικές Διαστάσεις
General Dimensions

A	B	H
1800	560	680

*διαστάσεις σε mm *dimensions in mm

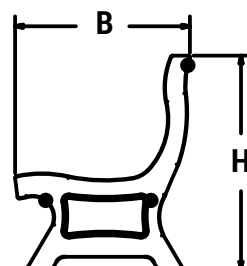
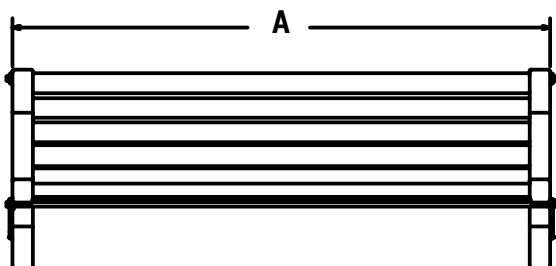
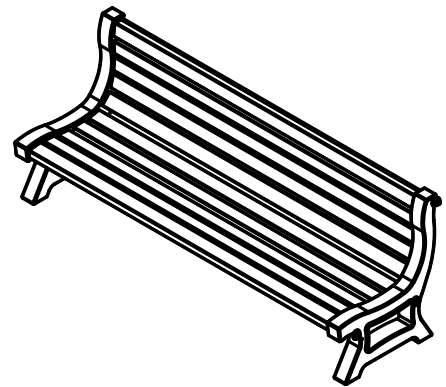

Κωδικός Προϊόντος | Product Code: S129



Γενικές Διαστάσεις
General Dimensions

A	B	H
1800	520	830

*διαστάσεις σε mm *dimensions in mm

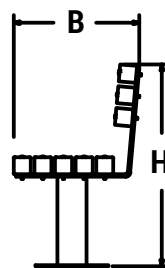
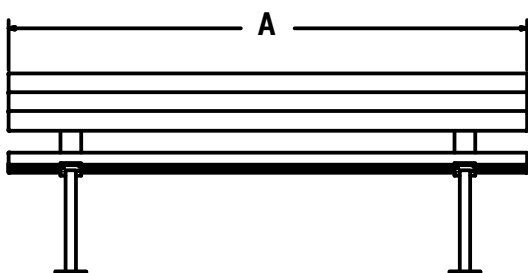
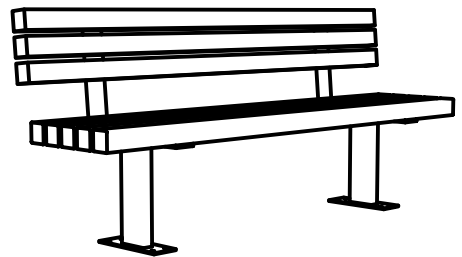

Κωδικός Προϊόντος | Product Code: S152



Γενικές Διαστάσεις	A	B	H
General Dimensions	1500 - 2000	580	800

*διαστάσεις σε mm *dimensions in mm

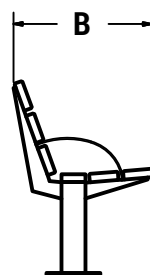
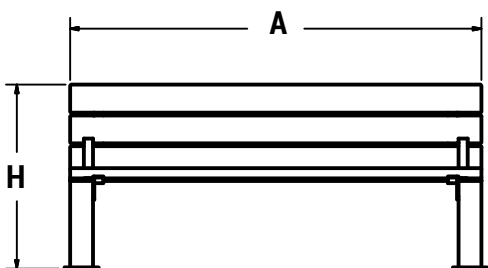
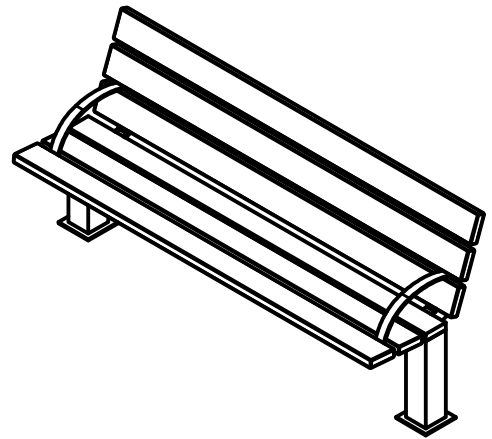

Κωδικός Προϊόντος | Product Code: S172



Γενικές Διαστάσεις
General Dimensions

A	B	H
1800	600	840

*διαστάσεις σε mm *dimensions in mm

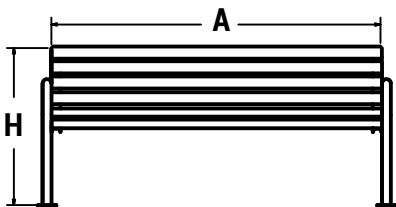
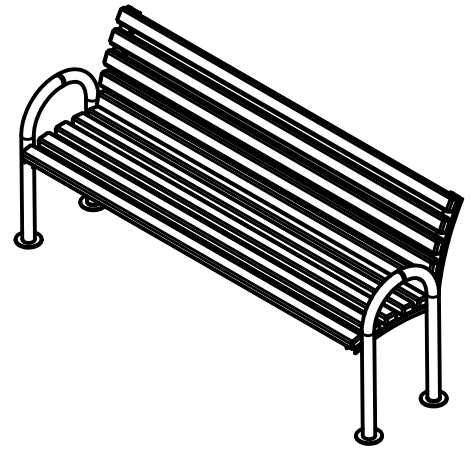

Κωδικός Προϊόντος | Product Code: N1



Γενικές Διαστάσεις
General Dimensions

A	B	H
1600 - 2000	530	850

*διαστάσεις σε mm *dimensions in mm

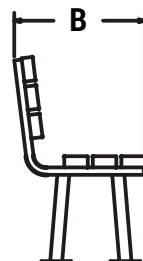
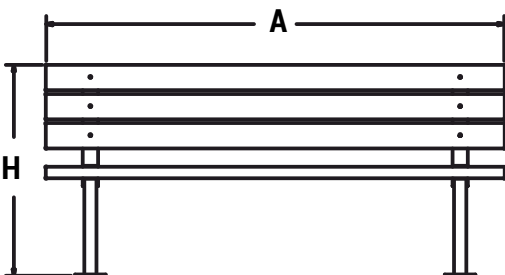
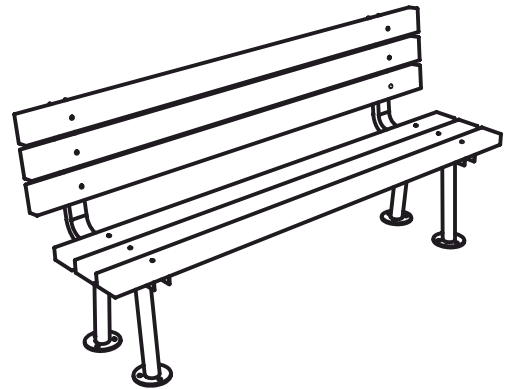

Κωδικός Προϊόντος | Product Code: S168



Γενικές Διαστάσεις
General Dimensions

A	B	H
1500 - 2000	470	710

*διαστάσεις σε mm *dimensions in mm

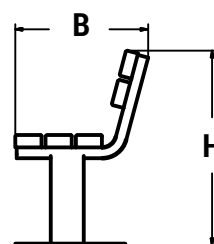
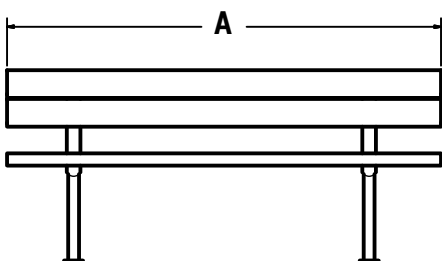
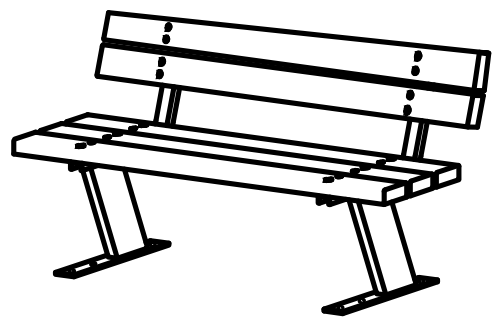

Κωδικός Προϊόντος | Product Code: S144



Γενικές Διαστάσεις
General Dimensions

A	B	H
1500 - 2000	500	790

*διαστάσεις σε mm *dimensions in mm

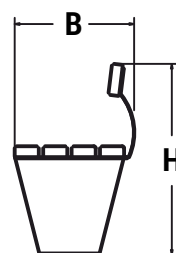
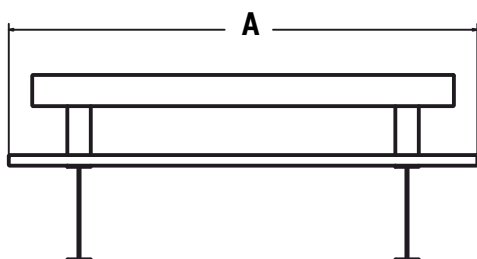
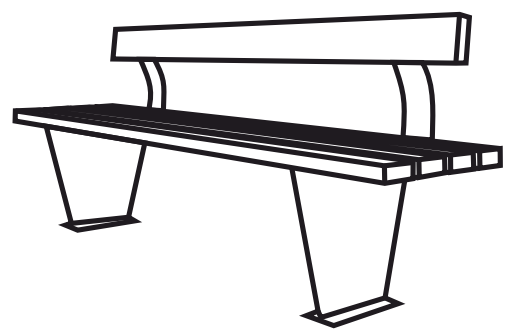

Κωδικός Προϊόντος | Product Code: S200



Γενικές Διαστάσεις General Dimensions	A	B	H
	1500 -2000	500	800

*διαστάσεις σε mm *dimensions in mm

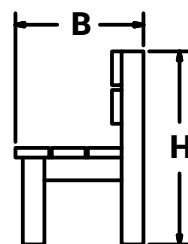
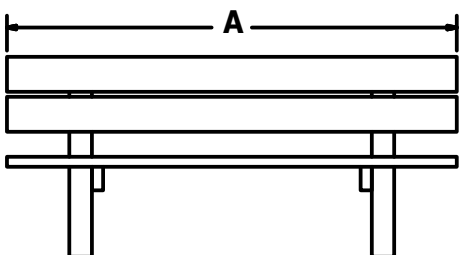
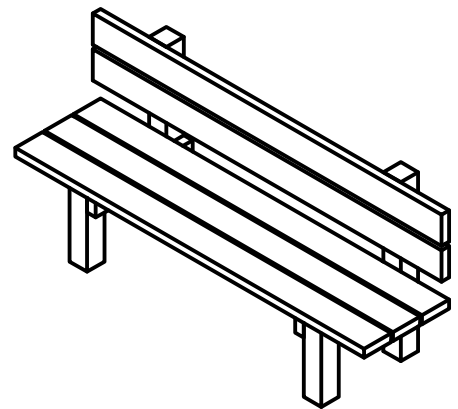

Κωδικός Προϊόντος / Product Code: PD01



Γενικές Διαστάσεις General Dimensions	A	B	H
	1400 - 1700	590	770

*διαστάσεις σε mm *dimensions in mm

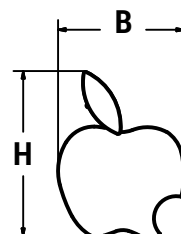
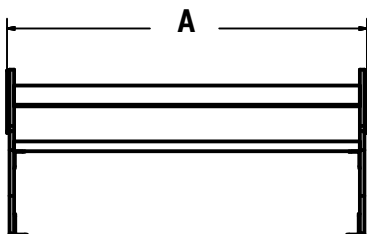
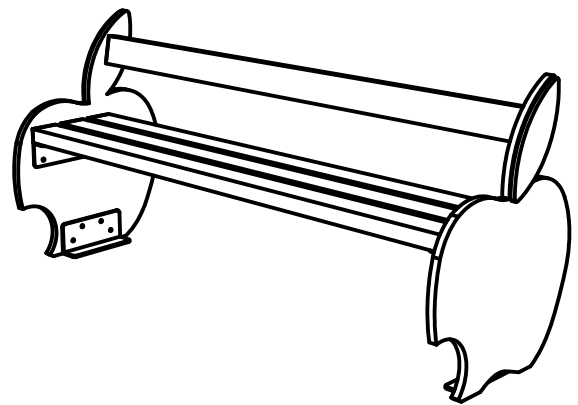

Κωδικός Προϊόντος | Product Code: S94



Γενικές Διαστάσεις
General Dimensions

A	B	B1	H
1500	400	300	450

*διαστάσεις σε mm *dimensions in mm

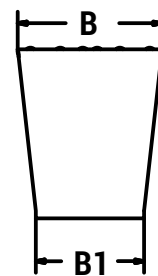
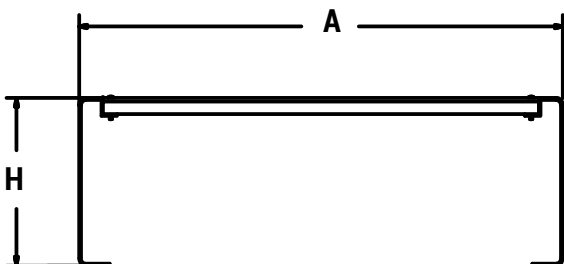
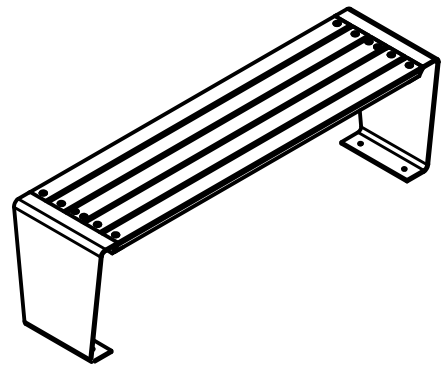

Κωδικός Προϊόντος | Product Code: S330



Γενικές Διαστάσεις
General Dimensions

A	B	H
1500	400	400

*διαστάσεις σε mm *dimensions in mm

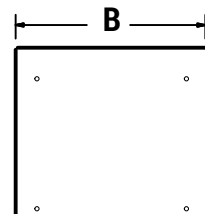
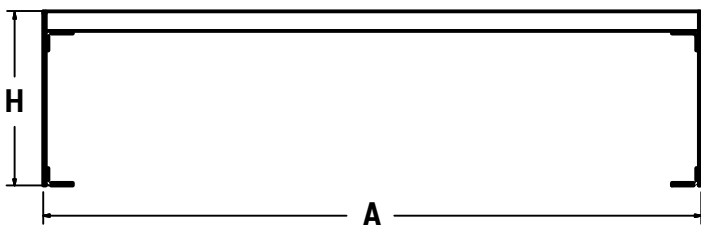
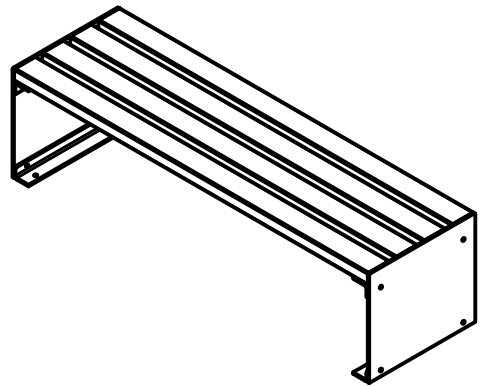

Κωδικός Προϊόντος | Product Code: S237



Γενικές Διαστάσεις General Dimensions	A	B	H
	1500 - 2000	645	590

*διαστάσεις σε mm *dimensions in mm

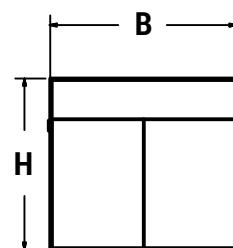
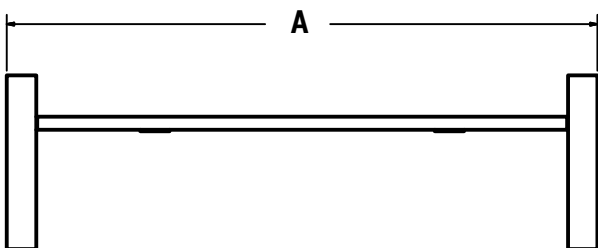
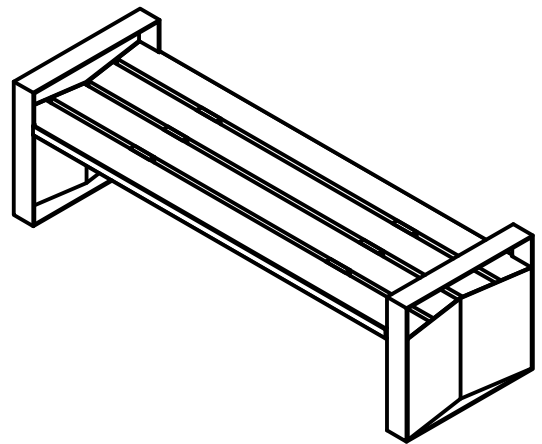

Κωδικός Προϊόντος | Product Code: S160



Γενικές Διαστάσεις
General Dimensions

A	B	H
1600	600	450

*διαστάσεις σε mm *dimensions in mm

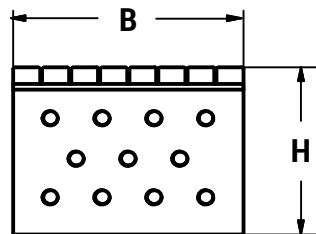
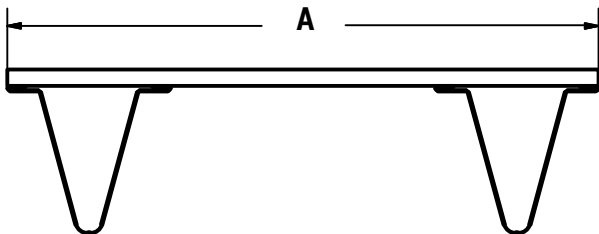
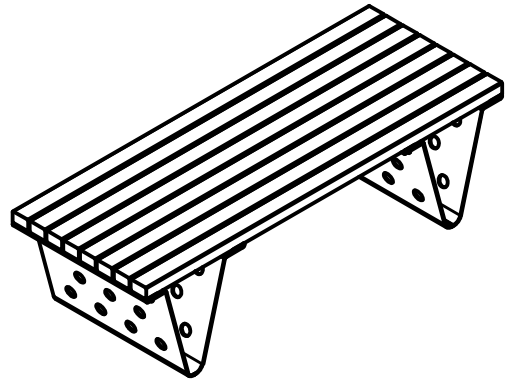

Κωδικός Προϊόντος | Product Code: S311



Γενικές Διαστάσεις
General Dimensions

A	B	H
2500	450	450

*διαστάσεις σε mm *dimensions in mm

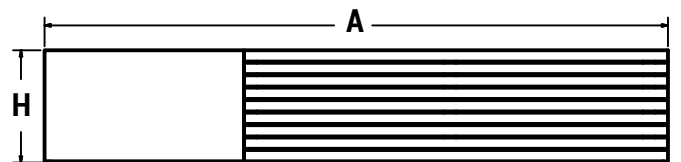
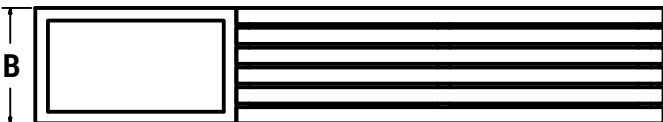
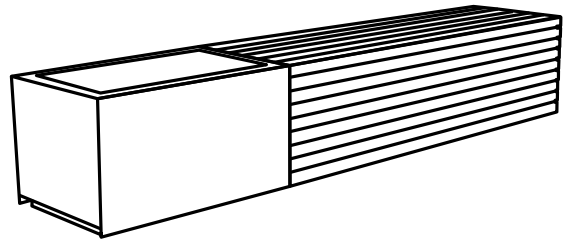

Κωδικός Προϊόντος | Product Code: S153



Γενικές Διαστάσεις
General Dimensions

A	B	B1	H
6000	1000	2000	450

*διαστάσεις σε mm *dimensions in mm

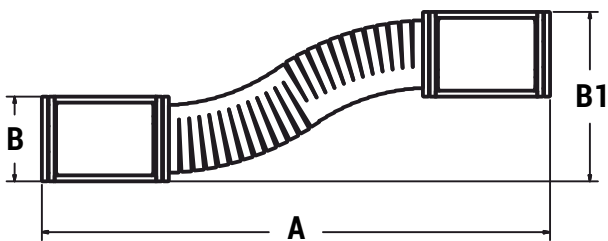
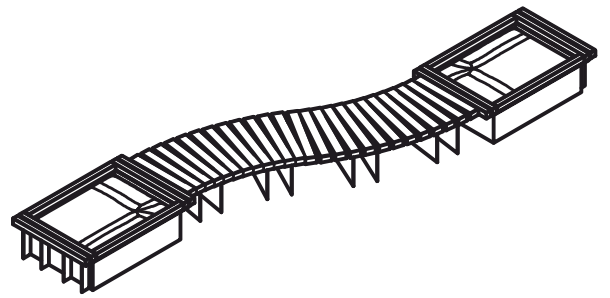

Κωδικός Προϊόντος | Product Code: S254



Γενικές Διαστάσεις
General Dimensions

A	B	H
2500	1600	450

*διαστάσεις σε mm *dimensions in mm

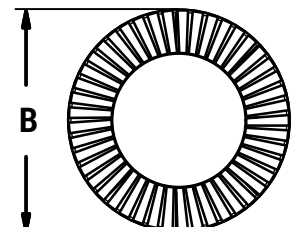
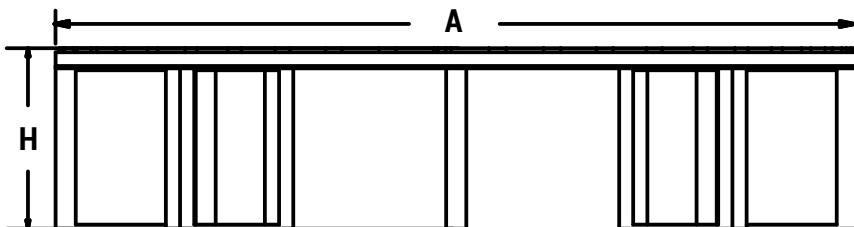
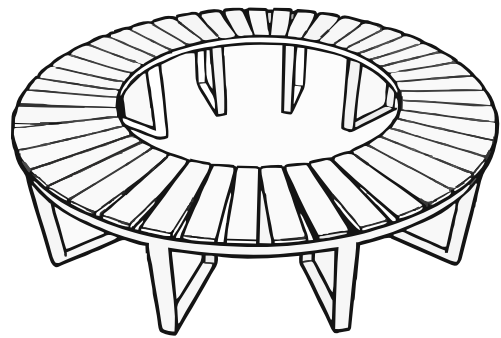

Κωδικός Προϊόντος | Product Code: S253



Γενικές Διαστάσεις
General Dimensions

A	B	H
2500	2500	450

*διαστάσεις σε mm *dimensions in mm

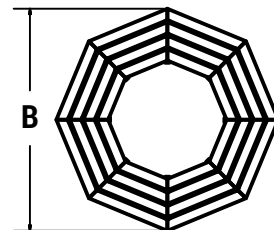
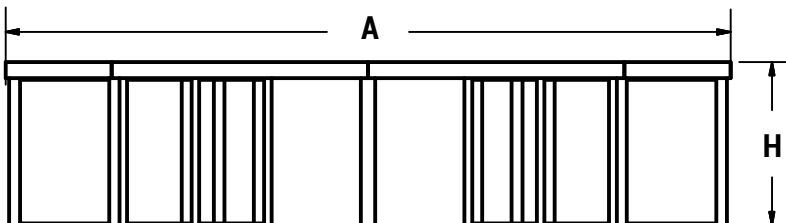
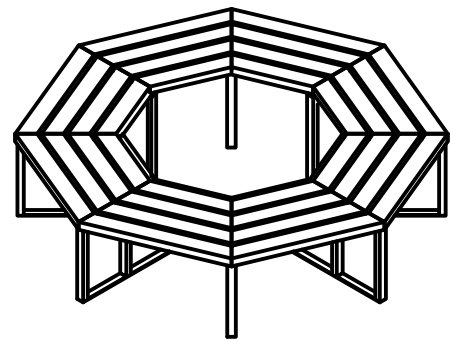

Κωδικός Προϊόντος | Product Code: S28-2 Ζαρτινιέρα
Flower pot



Κωδικός Προϊόντος | Product Code: S28

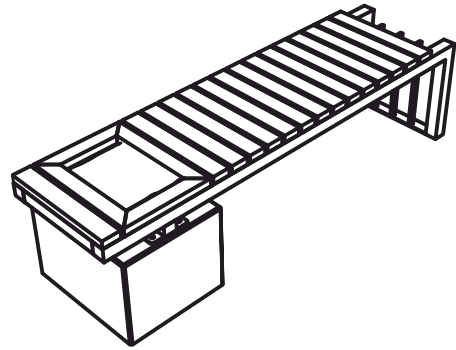
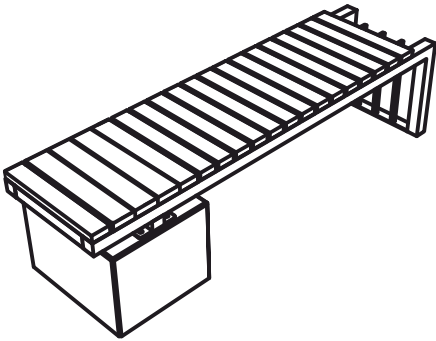

Γενικές Διαστάσεις
General Dimensions

A	B	H
1600 - 2000	450	450

Γενικές Διαστάσεις
General Dimensions

A	B	H
1600 - 2000	450	450

*διαστάσεις σε mm *dimensions in mm

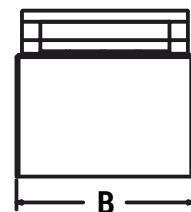
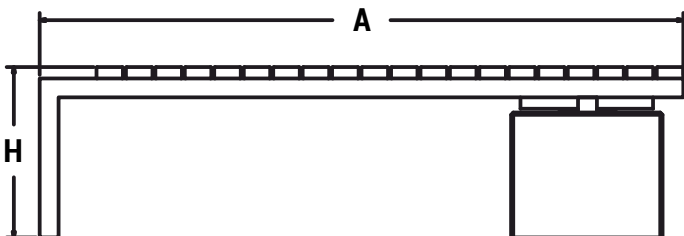



BENCHES

Concrete Based

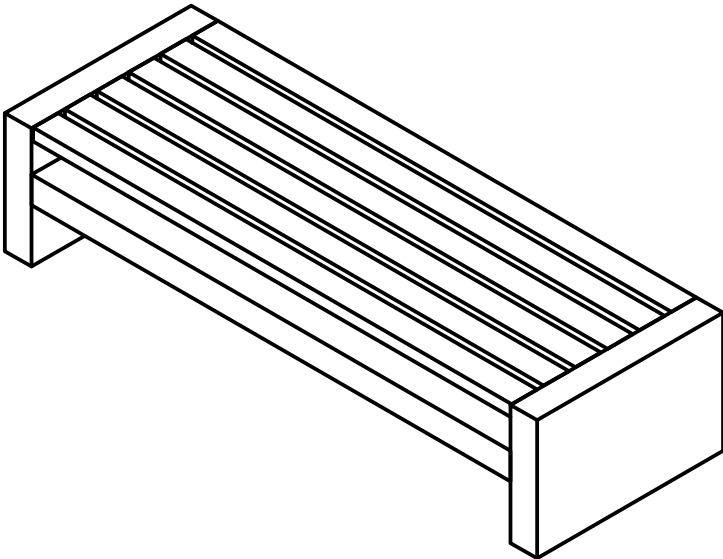

Γενικές Διαστάσεις General Dimensions	A	B	H
	2000	700	400

*διαστάσεις σε mm *dimensions in mm

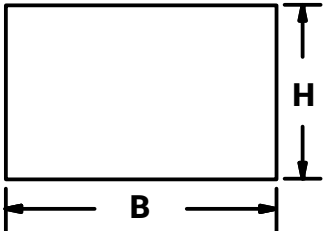
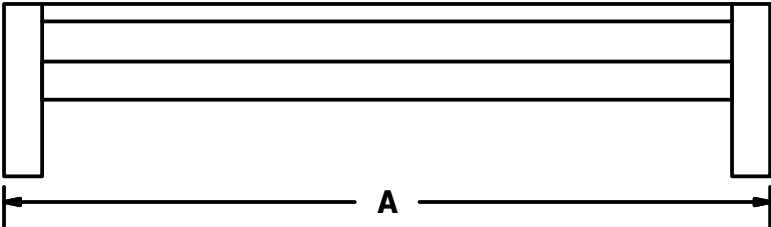

Κωδικός Προϊόντος | Product Code: S1



Γενικές Διαστάσεις / General Dimensions

S1	A	B	H	W
	2000	500	450	500kg

S1-2	A	B	H	W
	2000	500	400	500kg

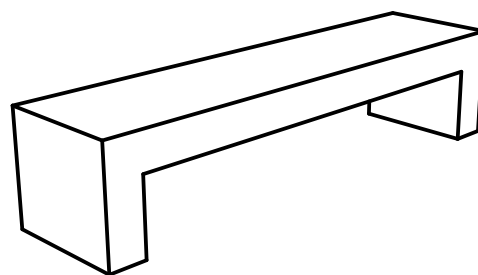

*διαστάσεις σε mm *dimensions in mm

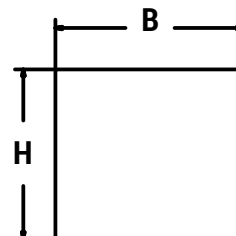
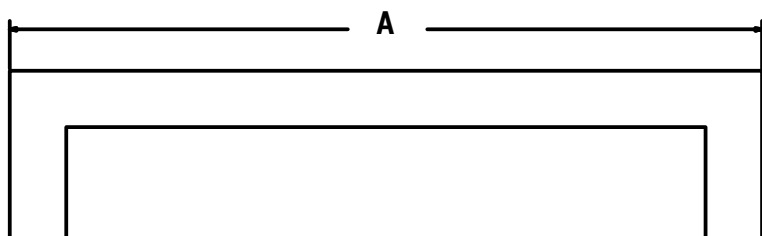

Κωδικός Προϊόντος | Product Code: S57

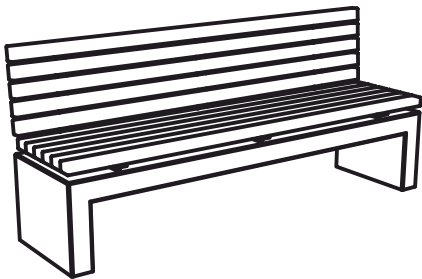

Γενικές Διαστάσεις
General Dimensions

A	B	H
2000	540	875

*διαστάσεις σε mm *dimensions in mm

W

600kg

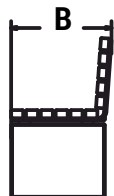
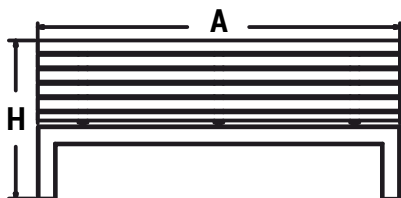

Κωδικός Προϊόντος | Product Code: S57 -1

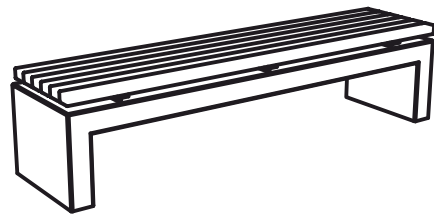

Γενικές Διαστάσεις
General Dimensions

A	B	H
2000	500	470

W

550kg

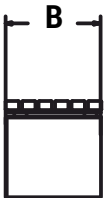
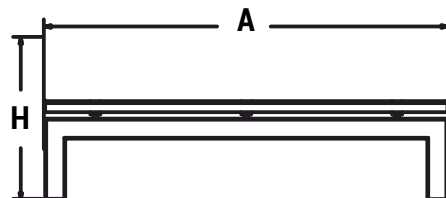

Κωδικός Προϊόντος | Product Code: S98



Κωδικός Προϊόντος | Product Code: S98 - 1

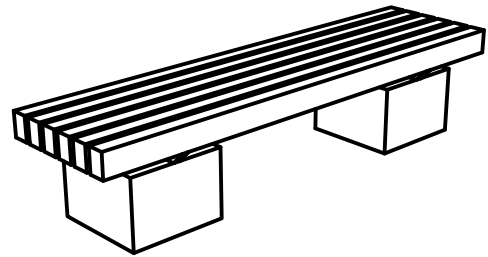
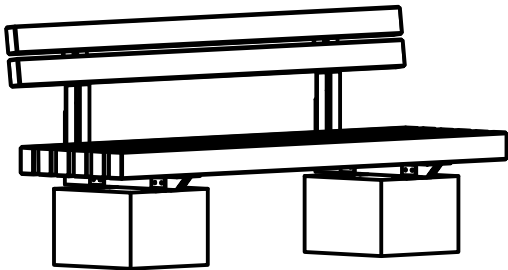

Γενικές Διαστάσεις
General Dimensions

A	B	H
2000	635	880

Γενικές Διαστάσεις
General Dimensions

A	B	H
2000	520	450

*διαστάσεις σε mm *dimensions in mm

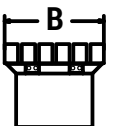
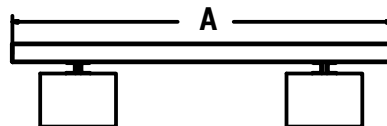
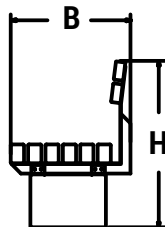
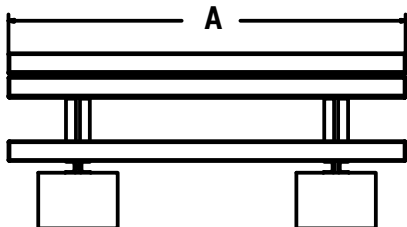

Κωδικός Προϊόντος | Product Code: S108

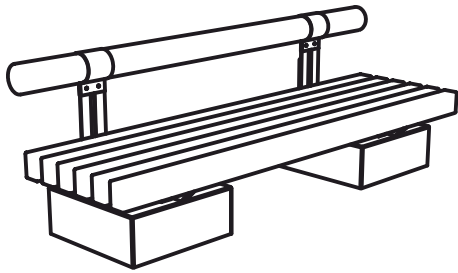

Γενικές Διαστάσεις
General Dimensions

A	B	H
2000	650	680

*διαστάσεις σε mm *dimensions in mm

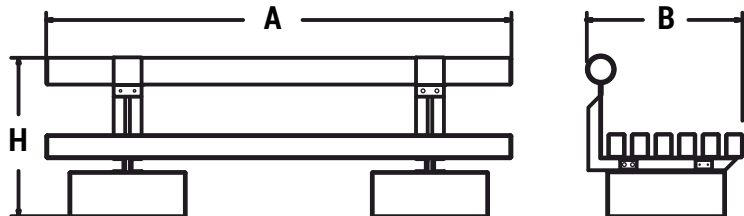

Κωδικός Προϊόντος | Product Code: S108 - 1

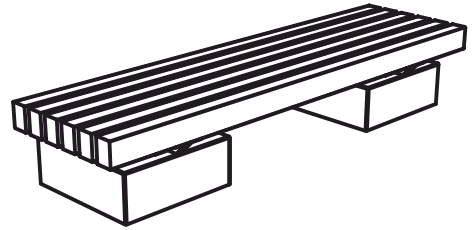
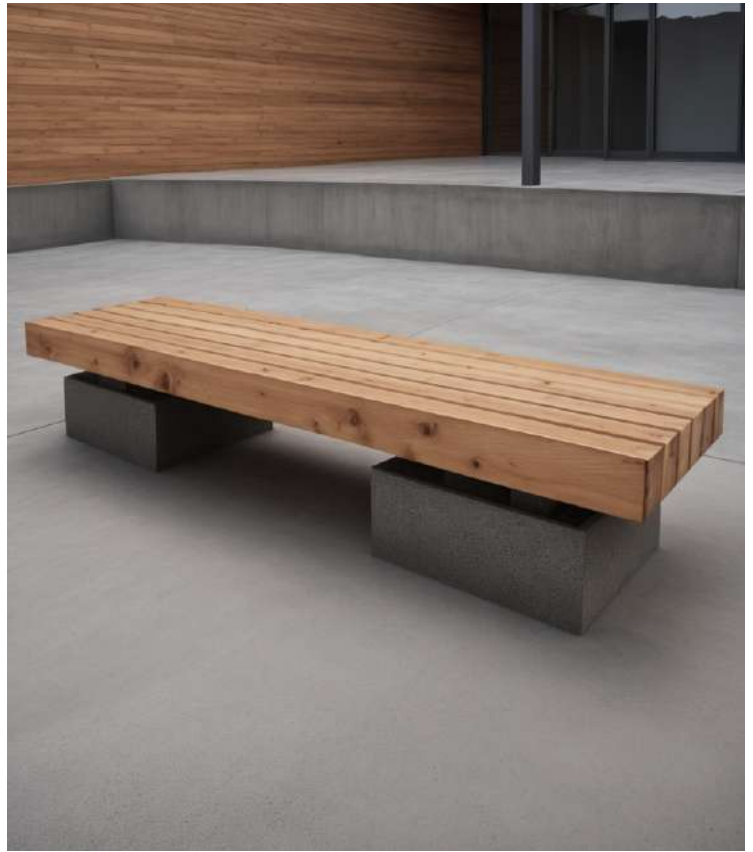

Γενικές Διαστάσεις
General Dimensions

A	B	H
2000	550	350

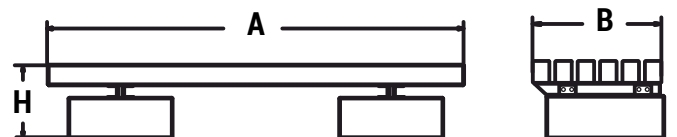

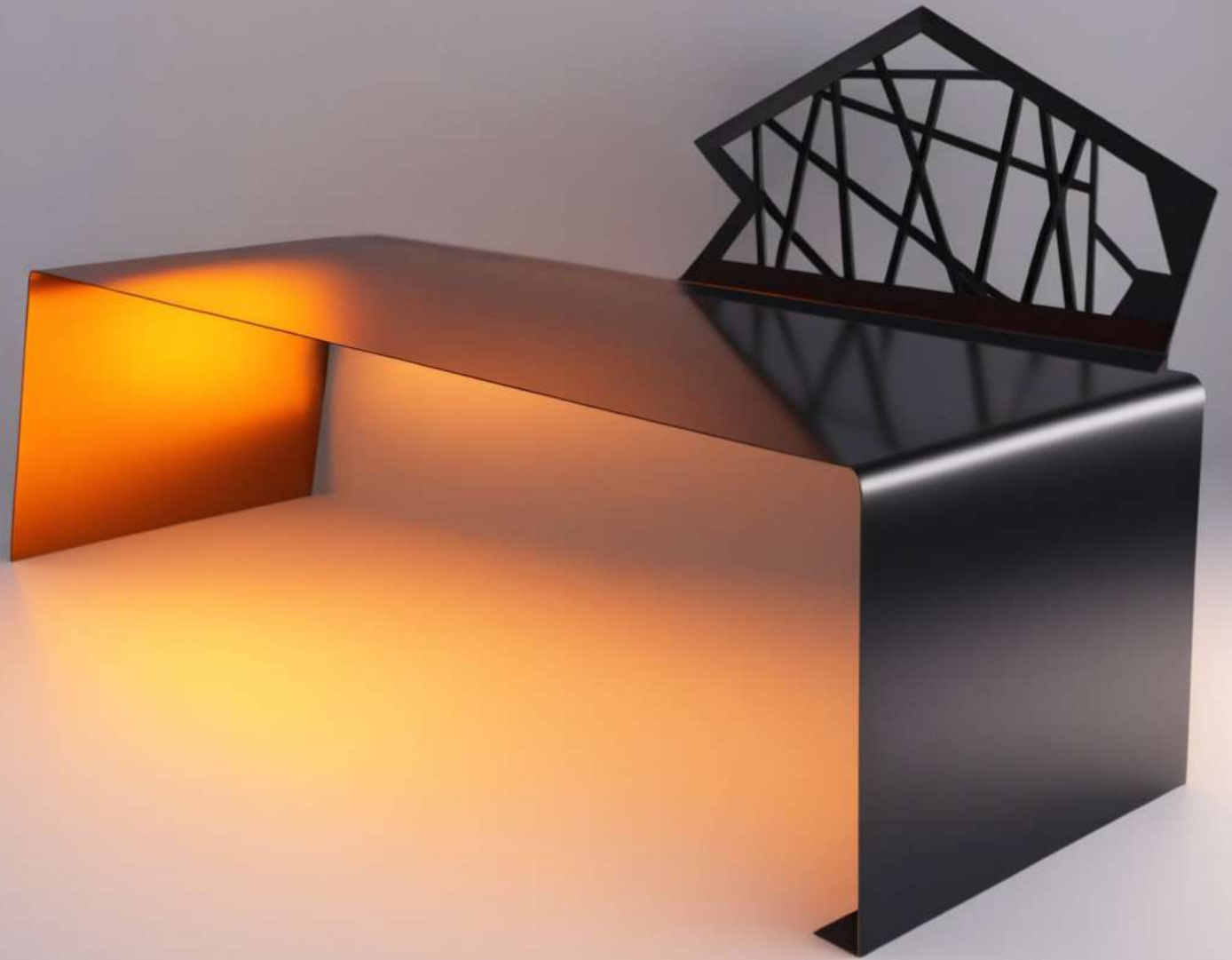

BENCHES
Metal

Κωδικός Προϊόντος | Product Code: S340

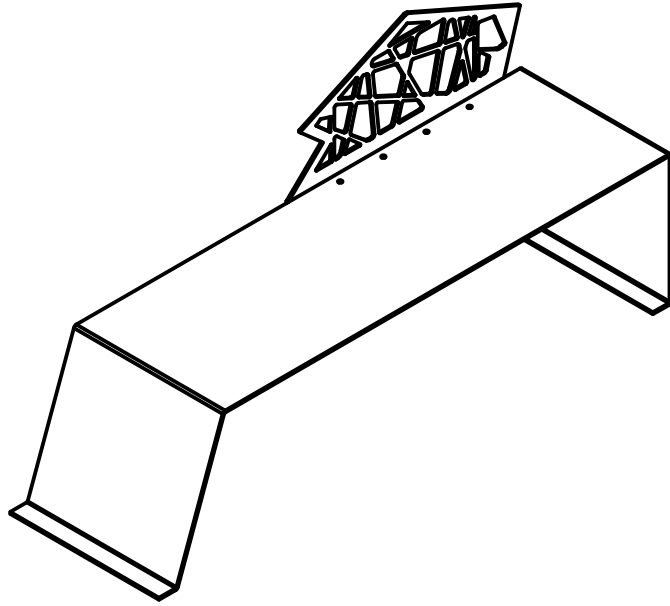

Γενικές Διαστάσεις General Dimensions	A	B	H
	1700	500	780

*διαστάσεις σε mm *dimensions in mm

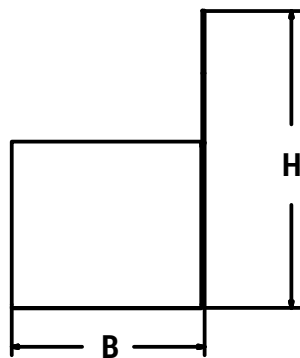
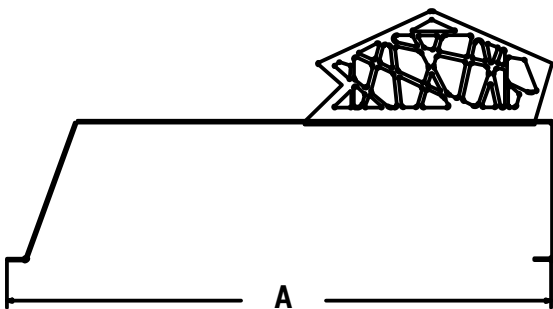

Κωδικός Προϊόντος | Product Code: S219



Γενικές Διαστάσεις General Dimensions	A	B	H
	1500 - 2000	700	900

*διαστάσεις σε mm *dimensions in mm

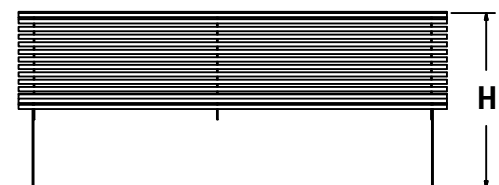
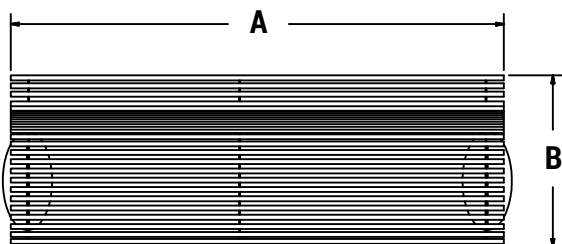
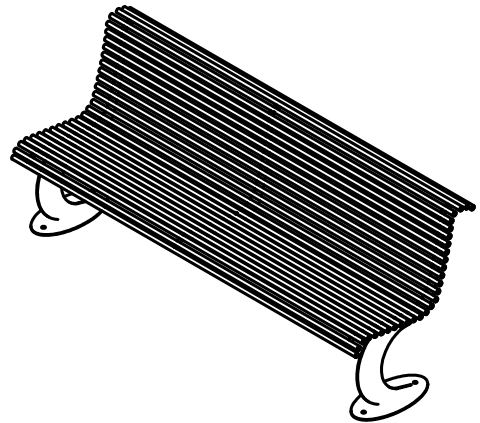

Κωδικός Προϊόντος | Product Code: S333



Κωδικός Προϊόντος | Product Code: S337

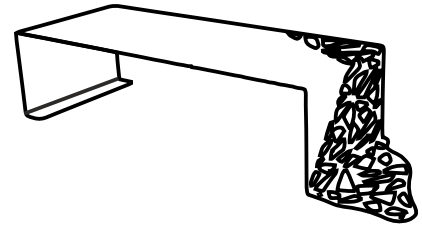
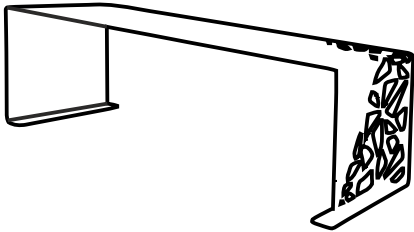

Γενικές Διαστάσεις
General Dimensions

A	B	H
1000	400	440

Γενικές Διαστάσεις
General Dimensions

A	B	H
1500	400	440

*διαστάσεις σε mm *dimensions in mm

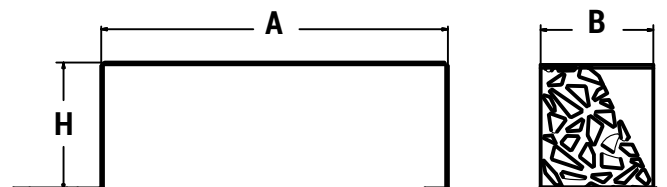
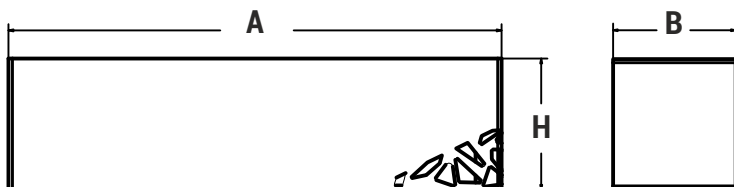



PICNIC TABLE

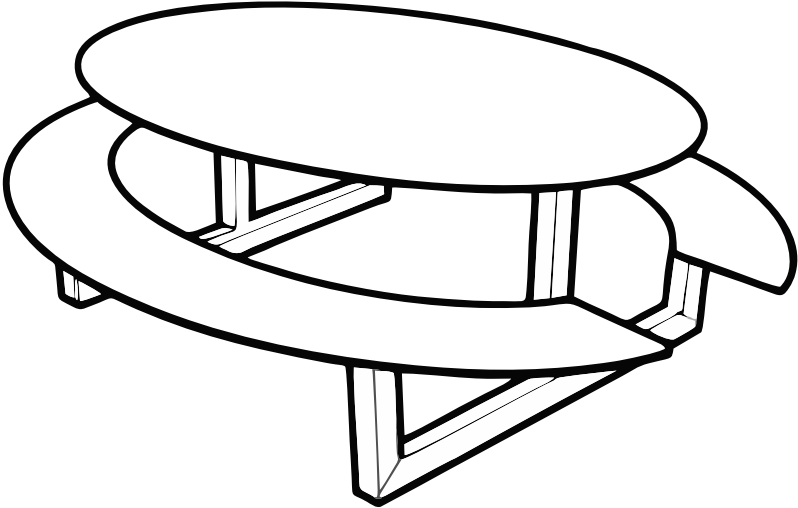

Γενικές Διαστάσεις General Dimensions	A	B	H
	2560	1850	750

*διαστάσεις σε mm *dimensions in mm

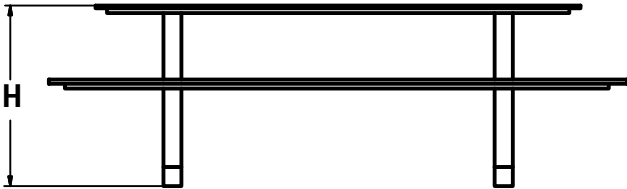
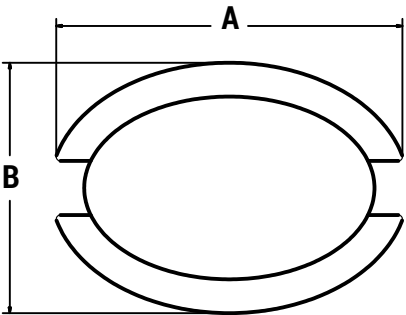

Κωδικός Προϊόντος | Product Code: ΤΠ08-1



Γενικές Διαστάσεις
General Dimensions

A	B	H
2200	1800	800

*διαστάσεις σε mm *dimensions in mm

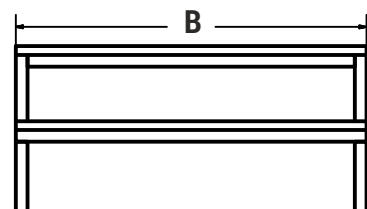
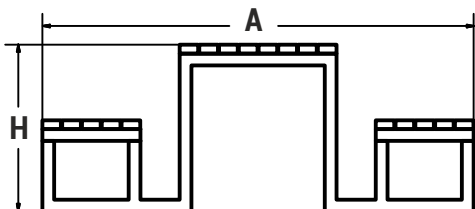
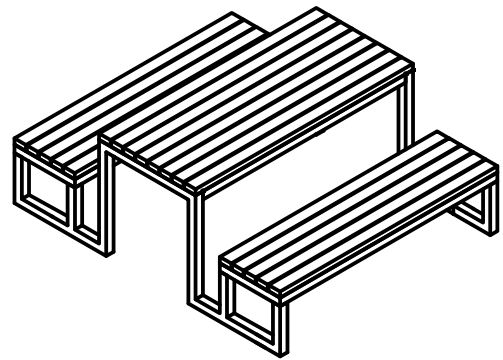

Κωδικός Προϊόντος | Product Code: ΤΠ08



Κωδικός Προϊόντος | Product Code: ΤΠ08 ΑΜΕΑ

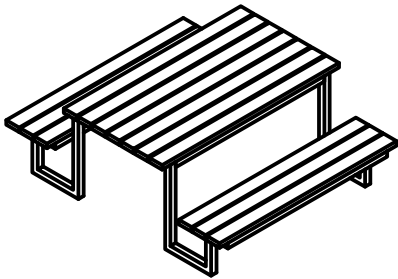

Γενικές Διαστάσεις
General Dimensions

A	B	H
2000	2500	800

*διαστάσεις σε mm *dimensions in mm

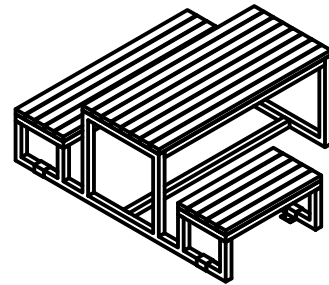

Γενικές Διαστάσεις
General Dimensions

A	B	H
2200	1800	800

*διαστάσεις σε mm *dimensions in mm

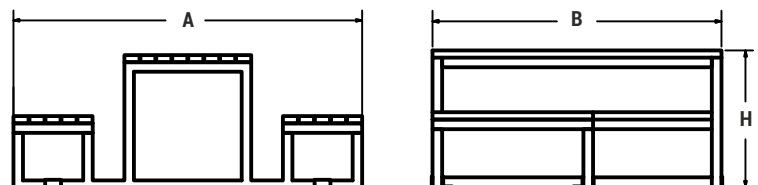
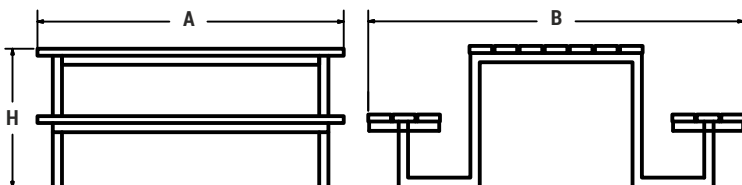

Κωδικός Προϊόντος | Product Code: ΤΠ032-1



Γενικές Διαστάσεις
General Dimensions

A	B	H
1800	1500	795

*διαστάσεις σε mm *dimensions in mm

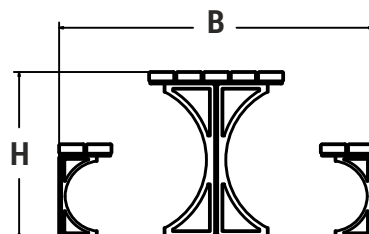
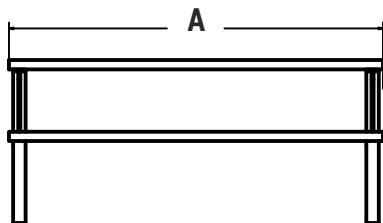
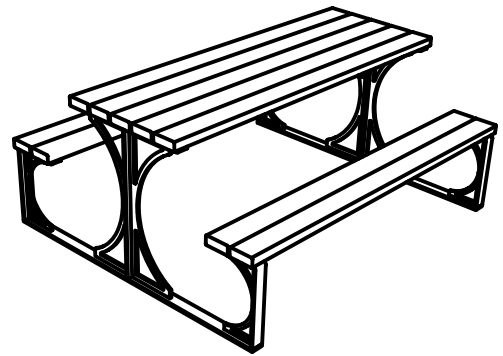

Κωδικός Προϊόντος | Product Code: ΤΠ014



Γενικές Διαστάσεις
General Dimensions

A	B	H
2500	2240	800

*διαστάσεις σε mm *dimensions in mm

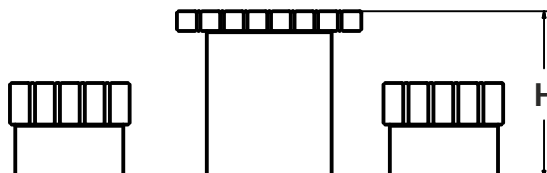
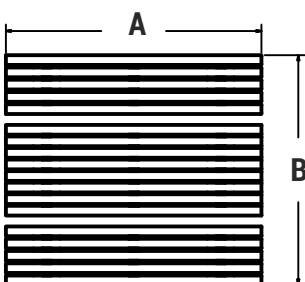
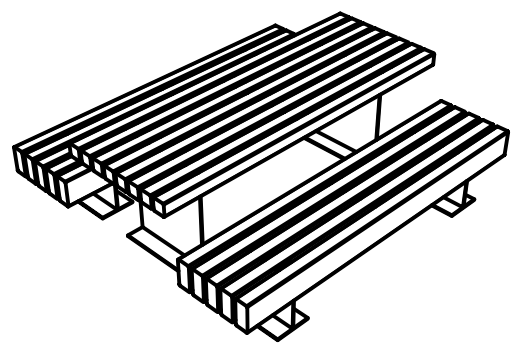

Κωδικός Προϊόντος | Product Code: ΤΠ015



Γενικές Διαστάσεις Τραπεζιού General Table Dimensions	A	B	H
	900	800	700

Γενικές Διαστάσεις Καθίσματος General Seat Dimensions	A	B	H
	450	420	450

*διαστάσεις σε mm *dimensions in mm

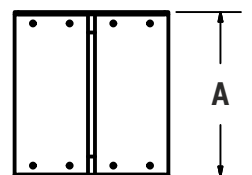
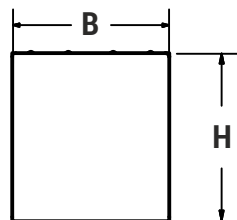
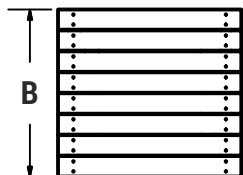
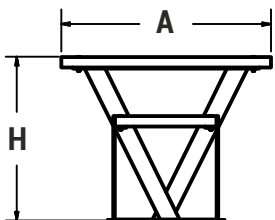
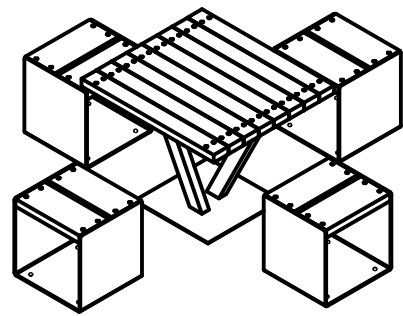

Κωδικός Προϊόντος | Product Code: ΤΠ016



Γενικές Διαστάσεις Τραπεζιού
General Table Dimensions

A	B	H
890	830	750

Γενικές Διαστάσεις Καθίσματος
General Seat Dimensions

A	B	H
450	420	450

*διαστάσεις σε mm *dimensions in mm

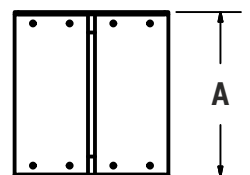
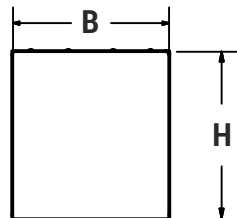
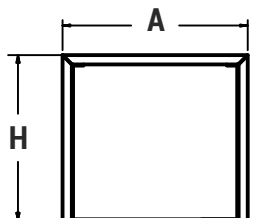
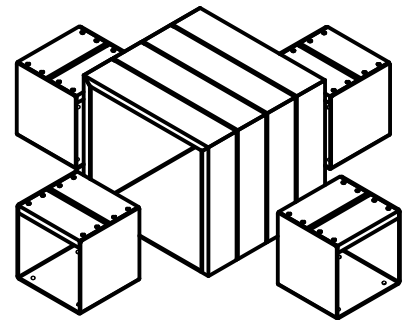

Κωδικός Προϊόντος | Product Code: ΤΠ032



Γενικές Διαστάσεις
General Dimensions

A	B	H
1500	1200	750

*διαστάσεις σε mm *dimensions in mm

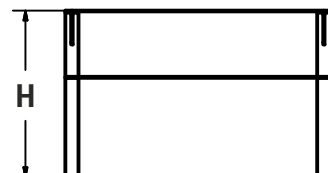
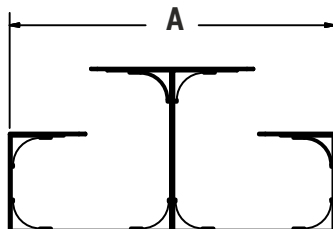
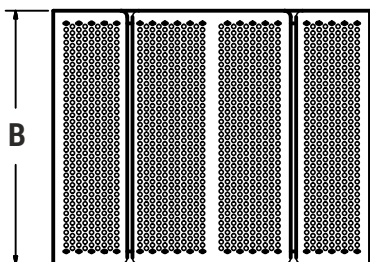
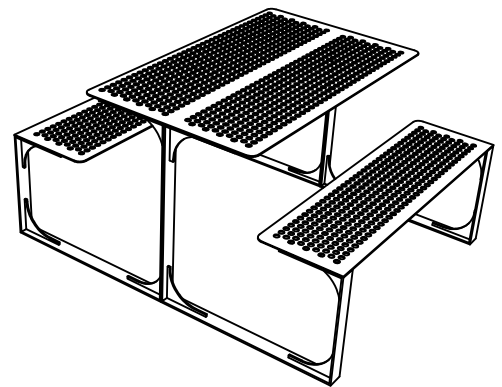

Κωδικός Προϊόντος | Product Code: ΤΠ010-3



Γενικές Διαστάσεις
General Dimensions

A	B	H
2700	2270	3270

*διαστάσεις σε mm *dimensions in mm

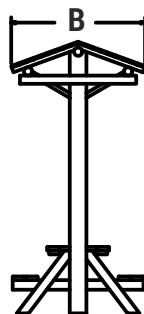
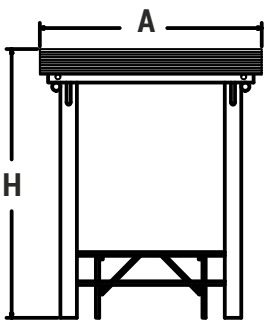
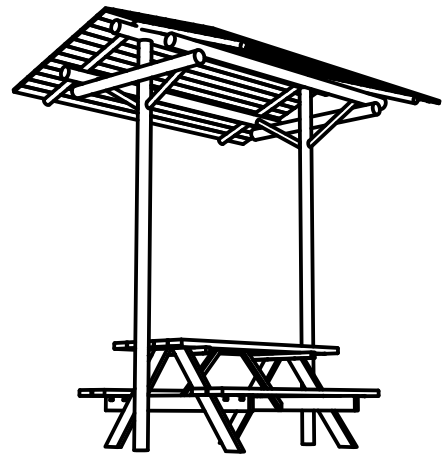

Κωδικός Προϊόντος | Product Code: ΤΠ011



Γενικές Διαστάσεις
General Dimensions

A	B	H
1800	1600	750

*διαστάσεις σε mm *dimensions in mm

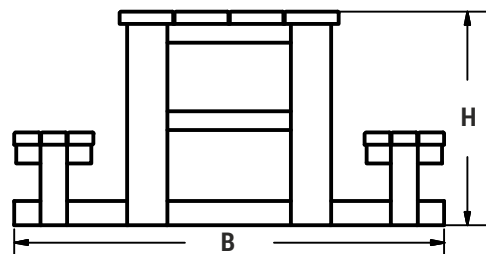
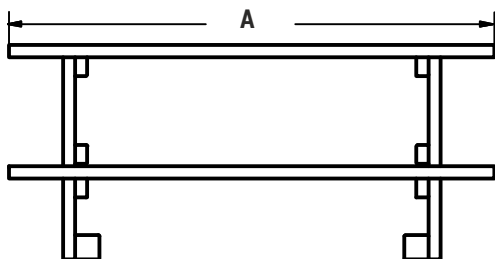
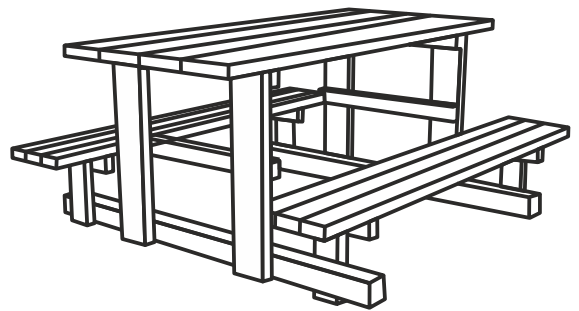

Κωδικός Προϊόντος | Product Code: ΤΠ010-2



Γενικές Διαστάσεις
General Dimensions

A	B	H
1800	1500	800

*διαστάσεις σε mm *dimensions in mm

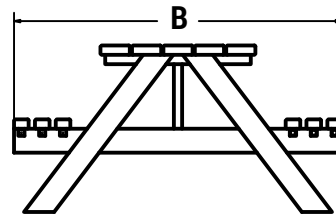
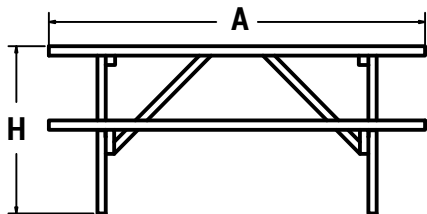
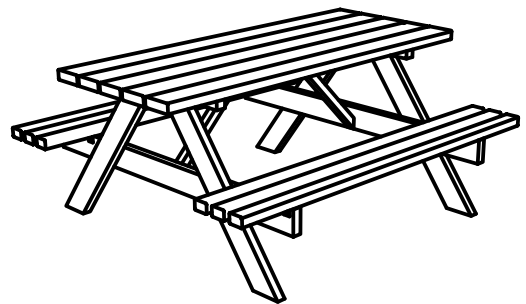

Κωδικός Προϊόντος | Product Code: ΤΠ027



Γενικές Διαστάσεις
General Dimensions

A	B	H
1300	1300	570

*διαστάσεις σε mm *dimensions in mm

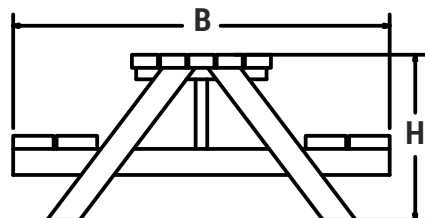
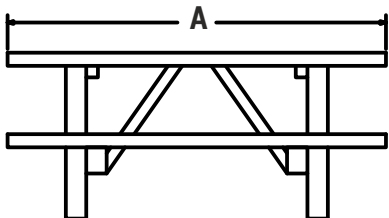
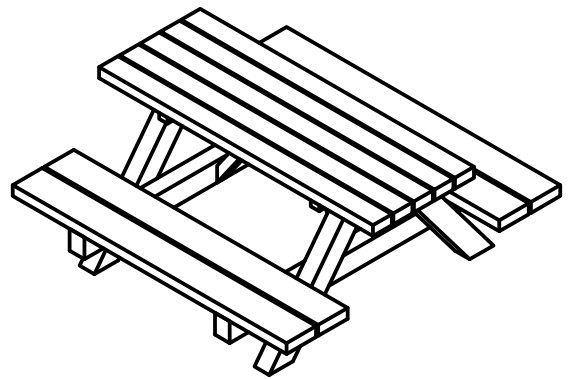



BINS

Metal

Κωδικός Προϊόντος | Product Code: N143

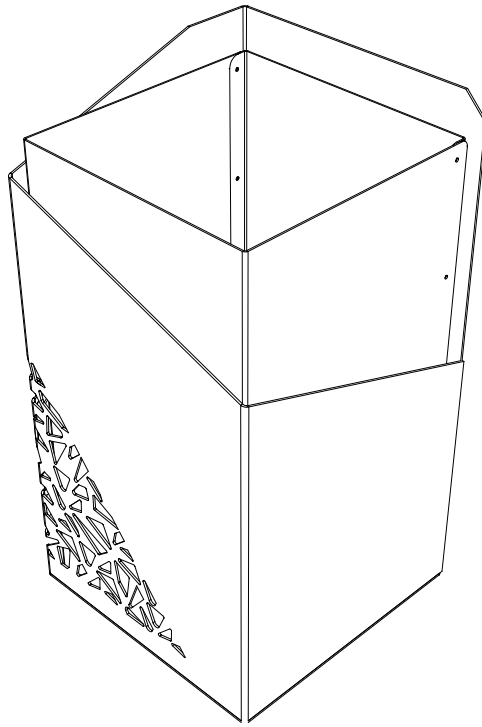

Γενικές Διαστάσεις
General Dimensions

H	H1	Lt
730	700	74

*διαστάσεις σε mm *dimensions in mm

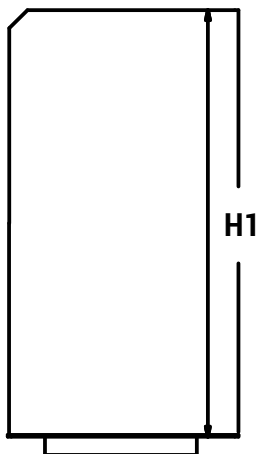
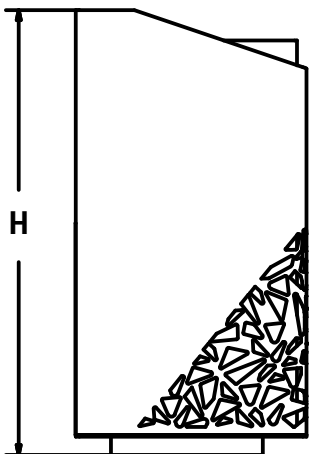

Κωδικός Προϊόντος | Product Code: N62



Γενικές Διαστάσεις
General Dimensions

A	B	H	H1	H2	Lt
300	300	1160	750	255	60

*διαστάσεις σε mm *dimensions in mm

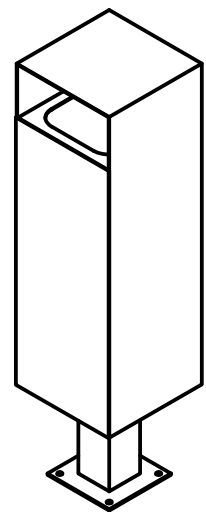
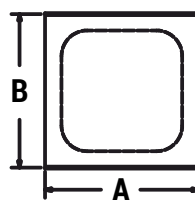
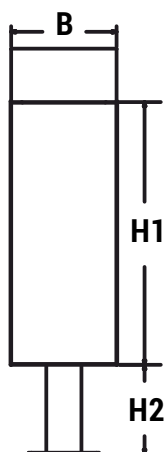
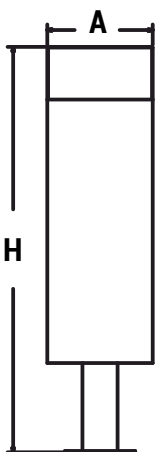

Κωδικός Προϊόντος | Product Code: N54



Γενικές Διαστάσεις
General Dimensions

A	B	H	Lt
320	320	1020	55

*διαστάσεις σε mm *dimensions in mm

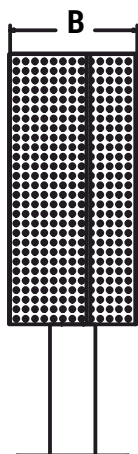
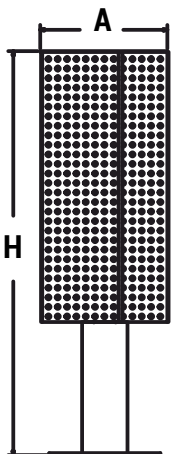
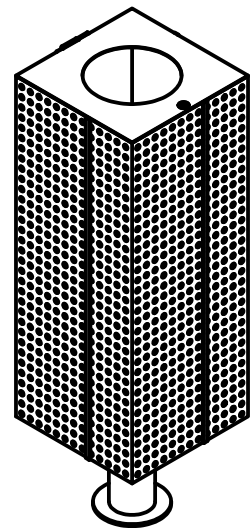

Κωδικός Προϊόντος | Product Code: N40



Γενικές Διαστάσεις
General Dimensions

D	D1	H	H1	Lt
580	300	850	550	40

*διαστάσεις σε mm *dimensions in mm

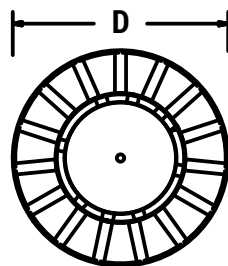
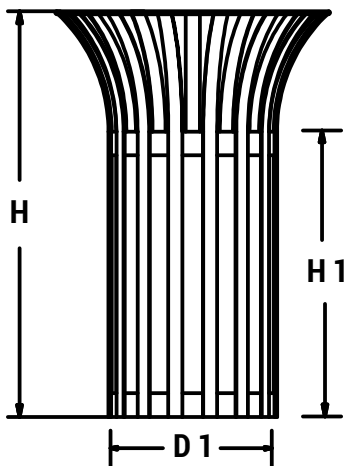
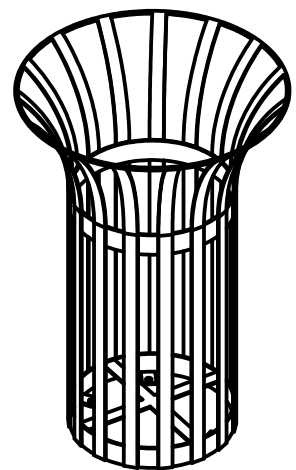

Κωδικός Προϊόντος | Product Code: N73



Γενικές Διαστάσεις General Dimensions	A	B	H	Lt
	600	600	950	132

*διαστάσεις σε mm *dimensions in mm

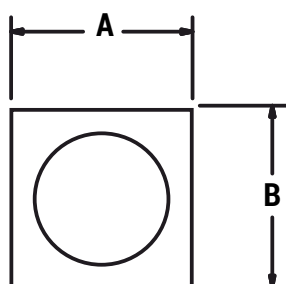
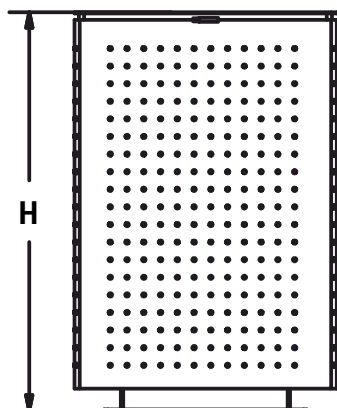
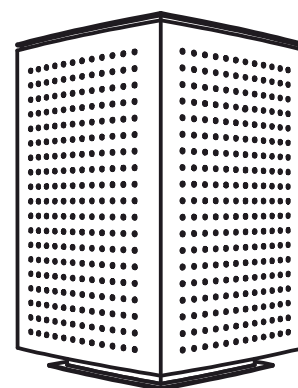

Κωδικός Προϊόντος | Product Code: N66



Γενικές Διαστάσεις
General Dimensions

A	B	H	H1	Lt
580	310	1100	790	90

*διαστάσεις σε mm *dimensions in mm

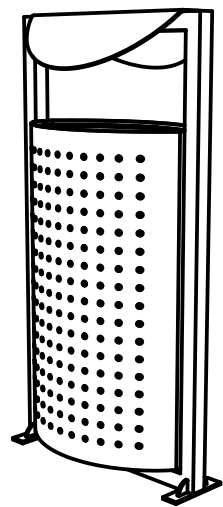
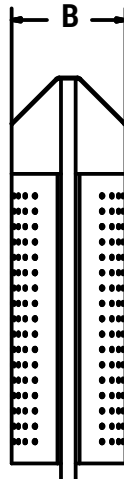
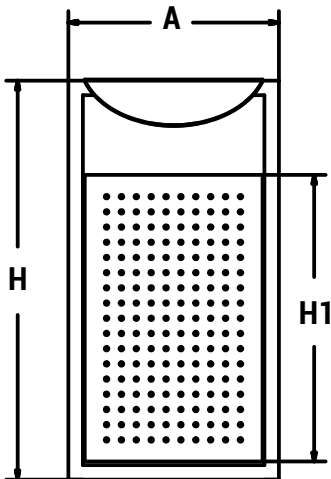

Κωδικός Προϊόντος | Product Code: N91



Γενικές Διαστάσεις
General Dimensions

D	H	H1	Lt
470	940	625	40

*διαστάσεις σε mm *dimensions in mm

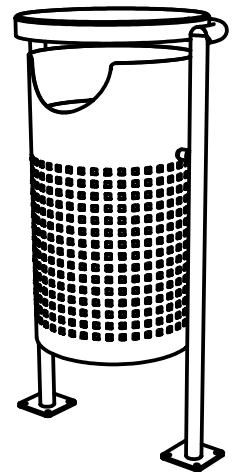
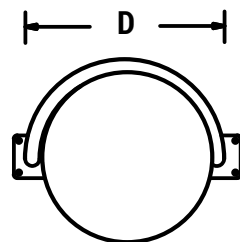
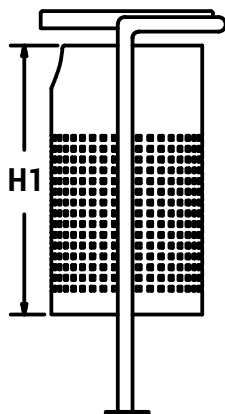
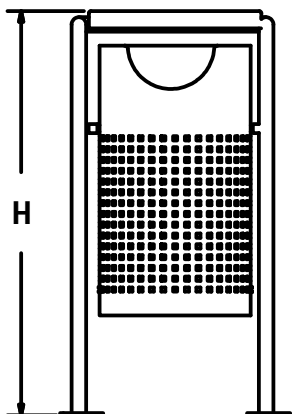

Κωδικός Προϊόντος | Product Code: N126



Γενικές Διαστάσεις
General Dimensions

A	B	H	Lt
415	482	910	67

*διαστάσεις σε mm *dimensions in mm

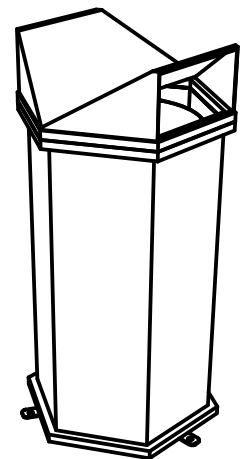
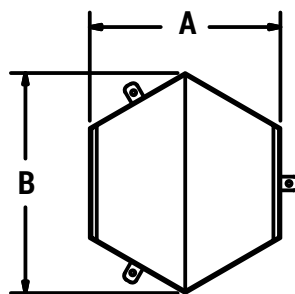
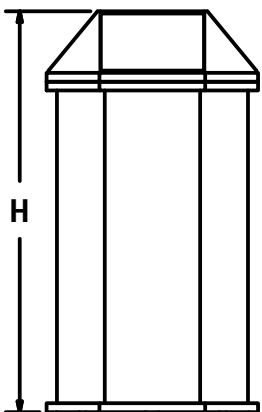

Κωδικός Προϊόντος | Product Code: N121



Γενικές Διαστάσεις
General Dimensions

A	B	H	Lt
410	445	900	75

*διαστάσεις σε mm *dimensions in mm

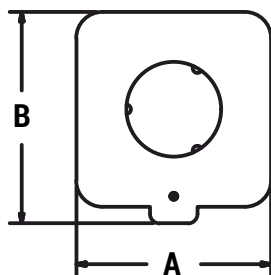
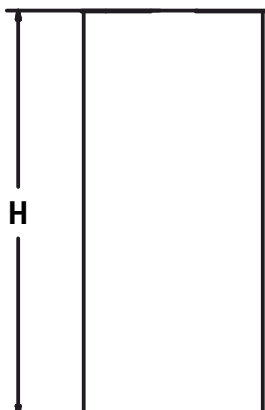
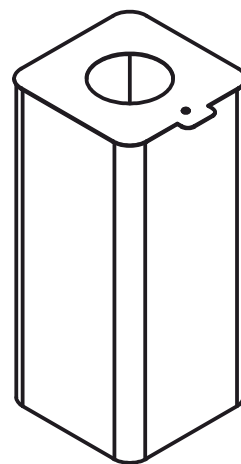

Κωδικός Προϊόντος | Product Code: N140



Γενικές Διαστάσεις
General Dimensions

A	B	H	Lt
350	300	1200	30

*διαστάσεις σε mm *dimensions in mm

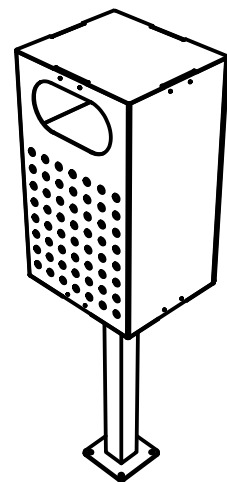
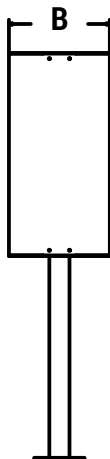
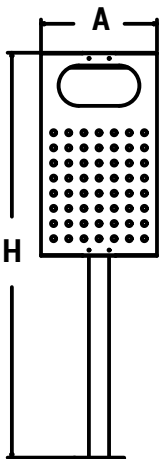

Κωδικός Προϊόντος | Product Code: N94



Γενικές Διαστάσεις
General Dimensions

A	B	H	Lt
500	440	1000	72

*διαστάσεις σε mm *dimensions in mm

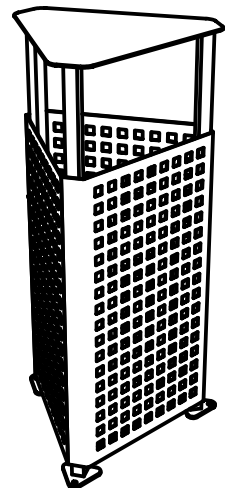
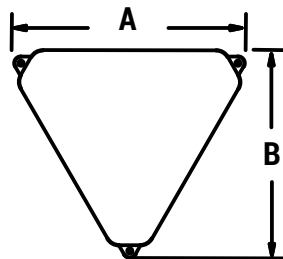
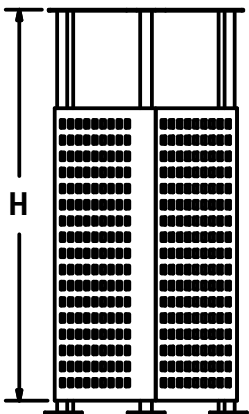

Κωδικός Προϊόντος | Product Code: N55



Γενικές Διαστάσεις
General Dimensions

D	H	Lt
460	890	95

*διαστάσεις σε mm *dimensions in mm

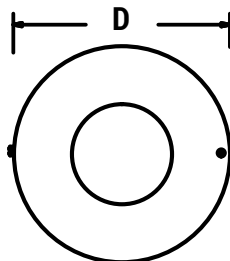
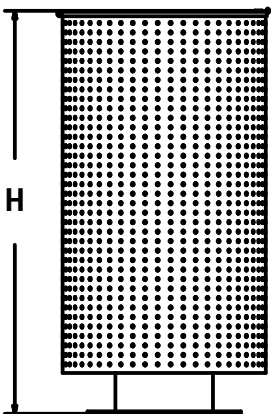
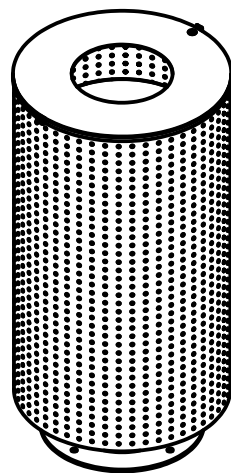

Κωδικός Προϊόντος | Product Code: N75



Γενικές Διαστάσεις
General Dimensions

D	H	Lt
480	800	100

*διαστάσεις σε mm *dimensions in mm

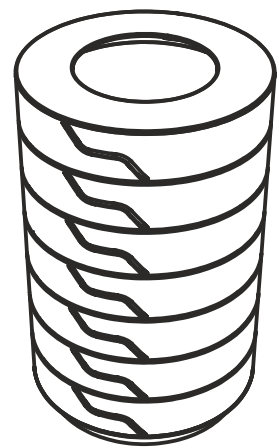
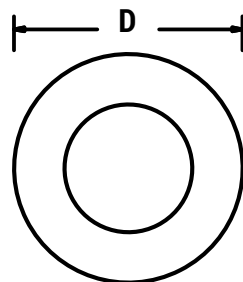
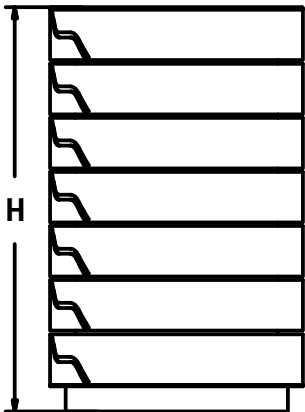

Κωδικός Προϊόντος | Product Code: N48



Γενικές Διαστάσεις
General Dimensions

	D	H	H1	Lt
N48 - 1	400	890	160	90
N48 - 2	470	890	165	125

*διαστάσεις σε mm *dimensions in mm

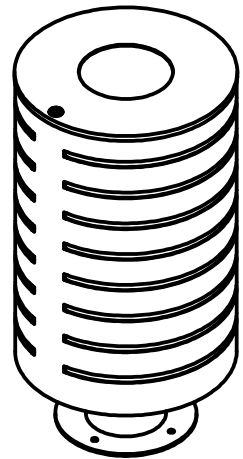
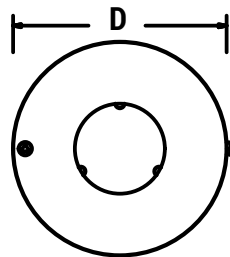
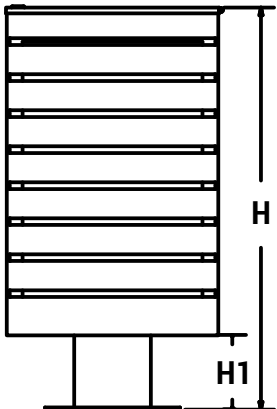

Κωδικός Προϊόντος | Product Code: N161



Γενικές Διαστάσεις
General Dimensions

D	H	H1	Lt
520	910	800	100

*διαστάσεις σε mm *dimensions in mm

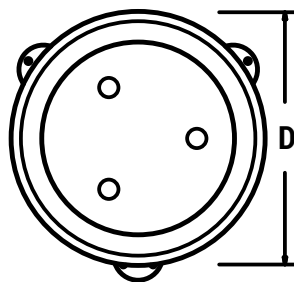
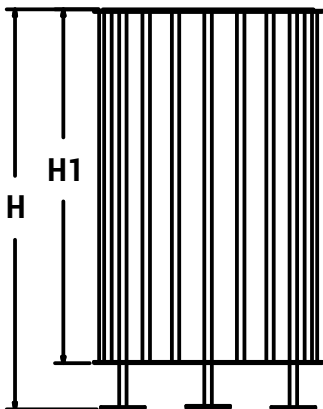
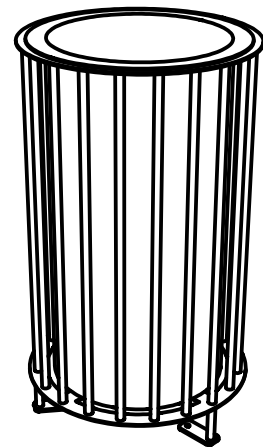

Κωδικός Προϊόντος | Product Code: N88



Γενικές Διαστάσεις
General Dimensions

D	H	Lt
675	850	152

*διαστάσεις σε mm *dimensions in mm

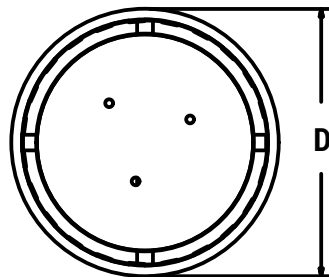
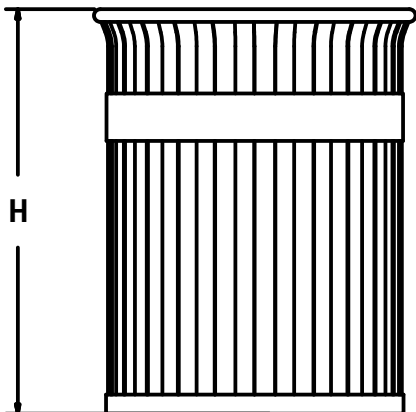
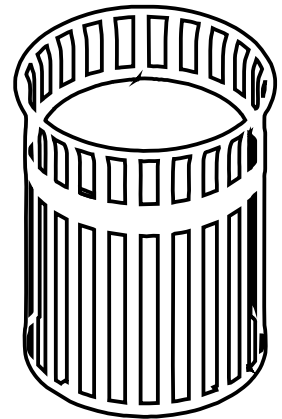

Κωδικός Προϊόντος | Product Code: N34



Κωδικός Προϊόντος | Product Code: N34-5

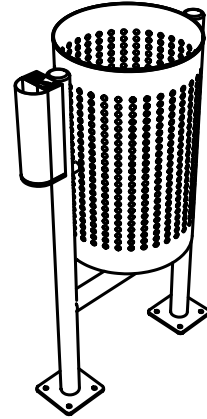
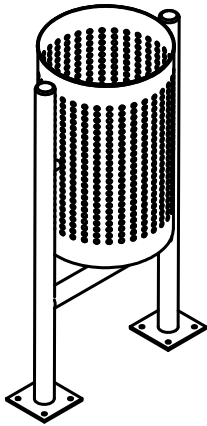

Γενικές Διαστάσεις
General Dimensions

D	H	H1	Lt
380	950	500	60

*διαστάσεις σε mm *dimensions in mm

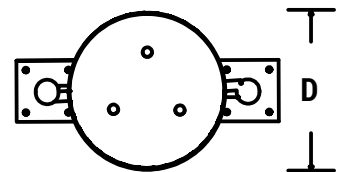
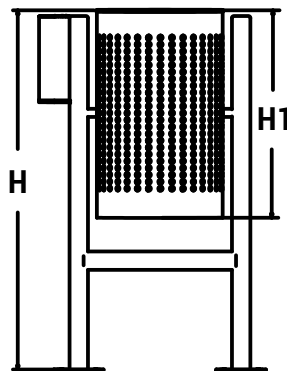
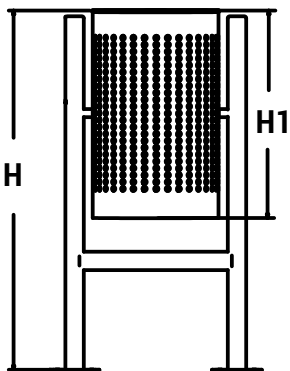

Κωδικός Προϊόντος | Product Code: N37



Γενικές Διαστάσεις / General Dimensions

N37-1A Μονός - Απλός / Single

D	H	Lt
300	1000	30

N37-1B Μονός - Τασάκι / Single
Ashtray

D	H	Lt
300	1000	30

*διαστάσεις σε mm *dimensions in mm

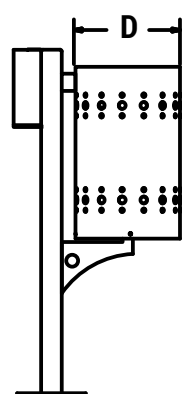
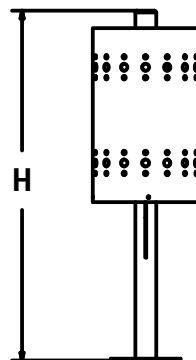
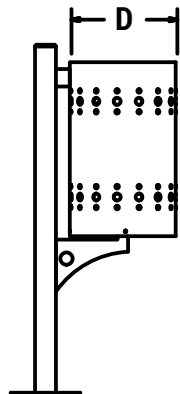
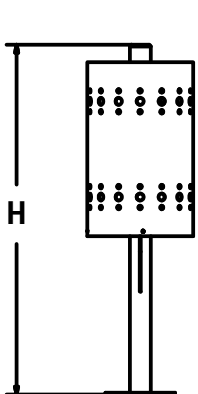

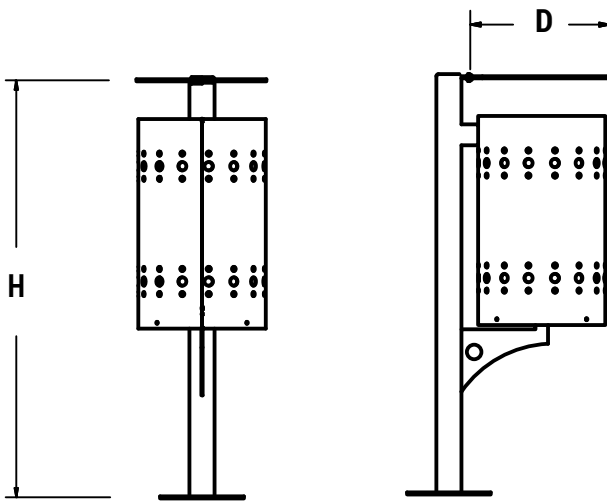
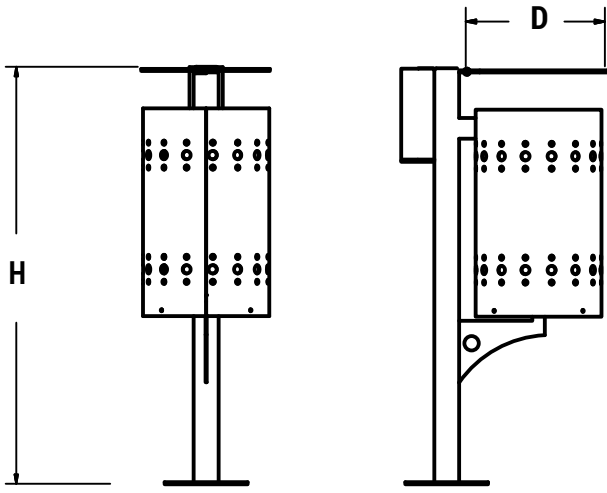

Γενικές Διαστάσεις / General Dimensions

N37-1B Μονός - Τασάκι - Καπάκι
Single - Ashtray - Lid

D	H	Lt
300	1000	30

N37-1A Μονός - Καπάκι / Single
Lid

D	H	Lt
300	1000	30

*διαστάσεις σε mm *dimensions in mm

Κωδικός Προϊόντος | Product Code: N37



Γενικές Διαστάσεις / General Dimensions

N37-2A Διπλός Απλός / Single

D	H	Lt
740	1000	60

**N37-2B Δίπλος Τασάκι /
Single Ashtray**

D	H	Lt
740	1000	60

*διαστάσεις σε mm *dimensions in mm

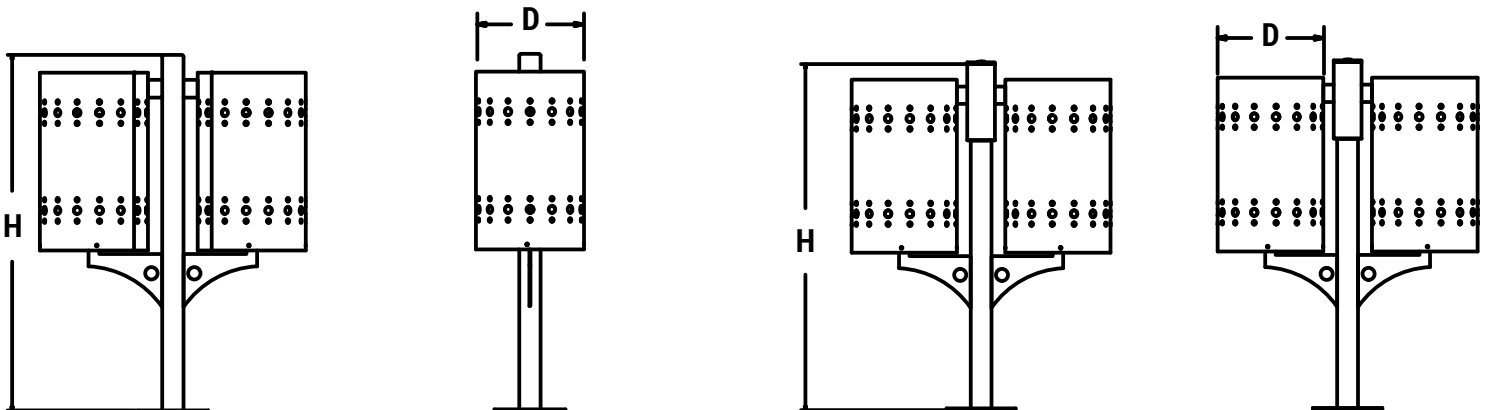

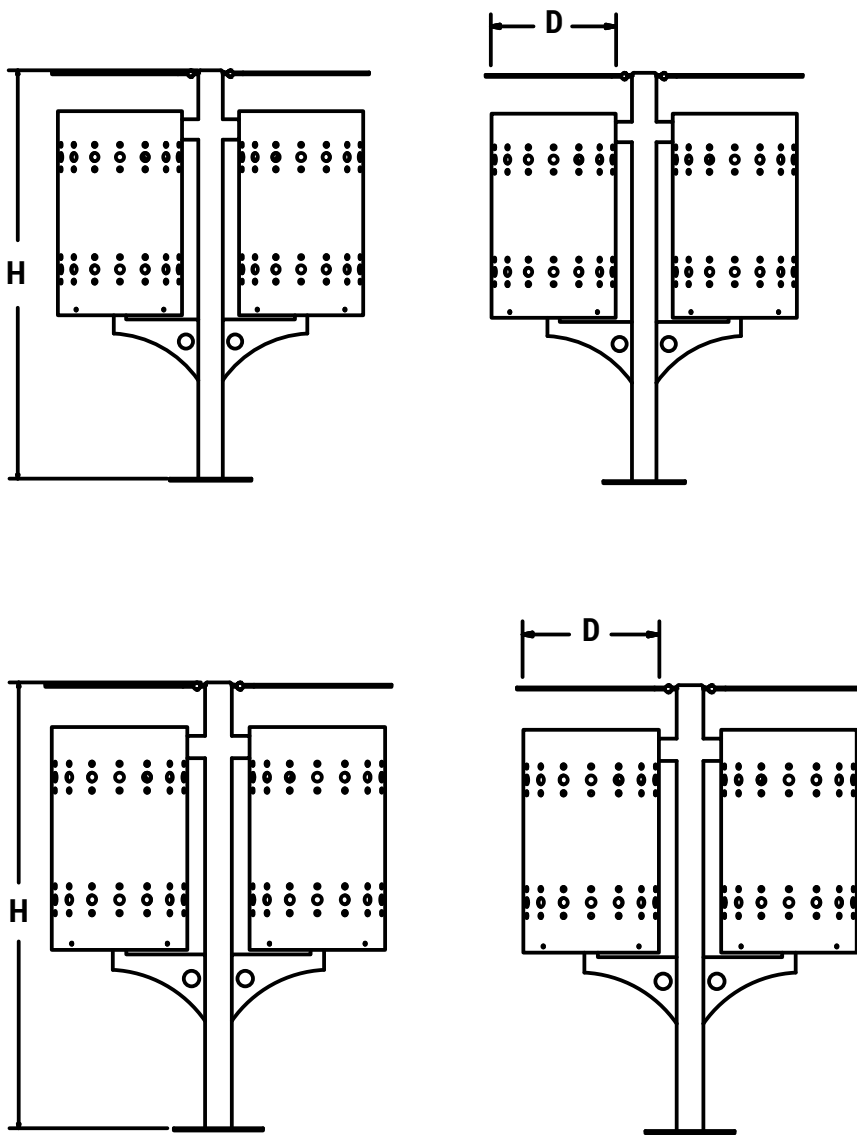

Γενικές Διαστάσεις / General Dimensions

N37-2C Διπλός - Καπάκι / Double Lid

D	H	Lt
740	1000	60

**N37-2D Διπλός - Τασάκι - Καπάκι
Double - Ashtray - Lid**

D	H	Lt
740	1000	30

*διαστάσεις σε mm *dimensions in mm

Κωδικός Προϊόντος | Product Code: N101



Γενικές Διαστάσεις
General Dimensions

H	D	Lt
891	450	57

*διαστάσεις σε mm *dimensions in mm

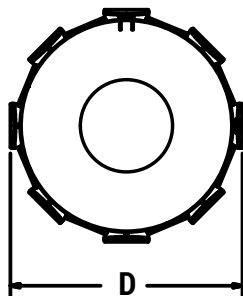
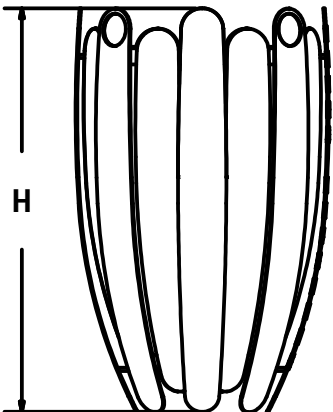
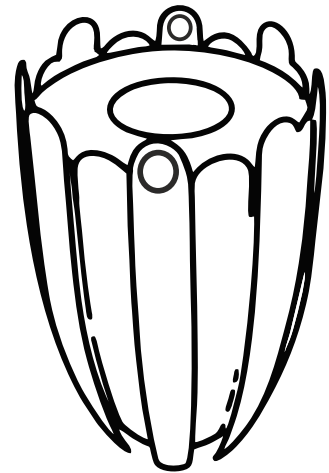



RECYCLE BINS

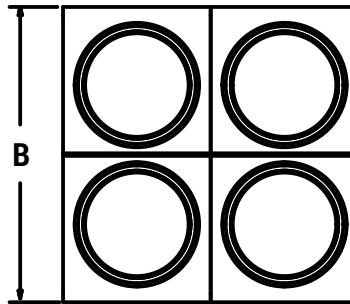
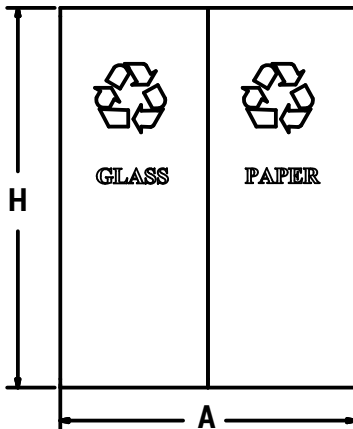
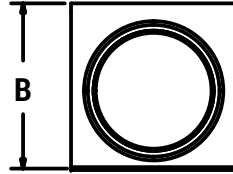
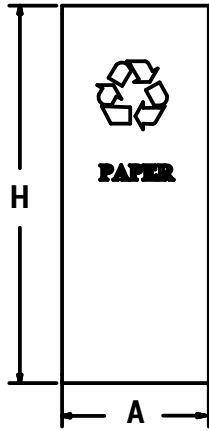

Γενικές Διαστάσεις / General Dimensions

**N47 - 1Κάδος
1Bin**

A	B	H	Lt
350	350	900	40kg

**N47-4 Κάδοι
4Bins**

A	B	H	Lt
700	700	900	160kg

*διαστάσεις σε mm *dimensions in mm



Γενικές Διαστάσεις
General Dimensions

A	B	H	Lt
400	400	800	91

*διαστάσεις σε mm *dimensions in mm

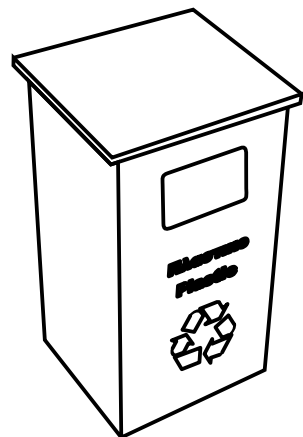
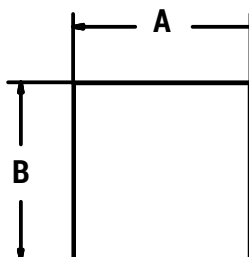
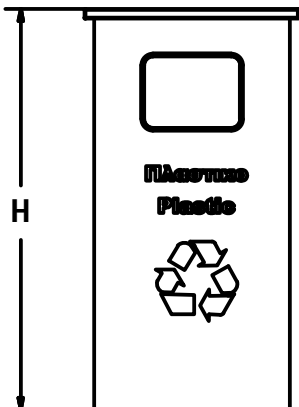

Κωδικός Προϊόντος | Product Code: N122



Γενικές Διαστάσεις
General Dimensions

A	B	H	Lt
210	540	790	59

*διαστάσεις σε mm *dimensions in mm

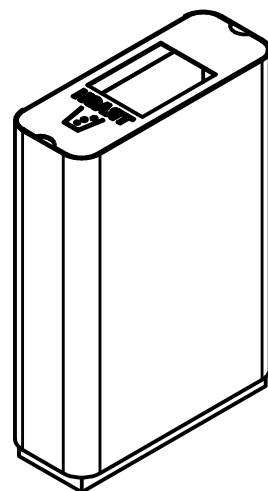
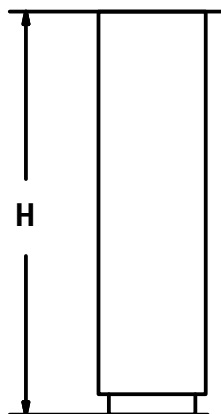
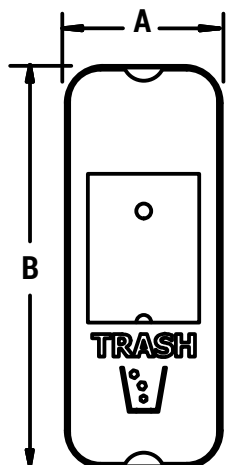

Κωδικός Προϊόντος | Product Code: N76



Γενικές Διαστάσεις
General Dimensions

	A	B	H	Lt
N76 SET	970	745	915	336
N76	970	745	915	84

*διαστάσεις σε mm *dimensions in mm

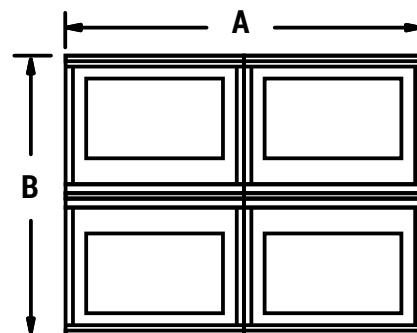
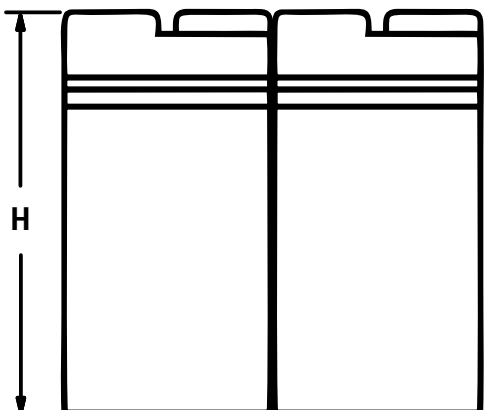
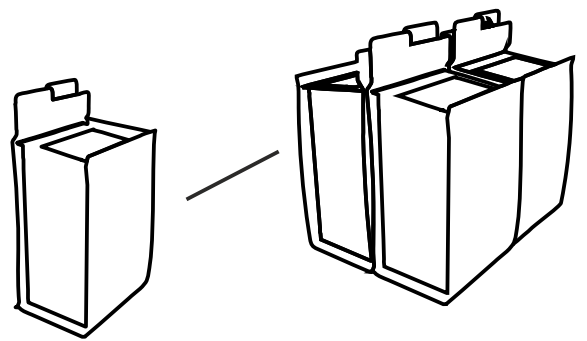

Κωδικός Προϊόντος | Product Code: N112



Γενικές Διαστάσεις
General Dimensions

A	B	H	Lt
500	500	1000	225

*διαστάσεις σε mm *dimensions in mm

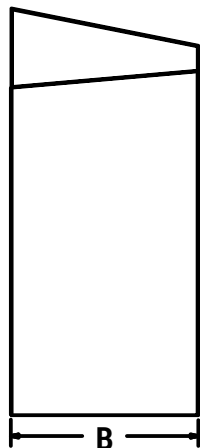
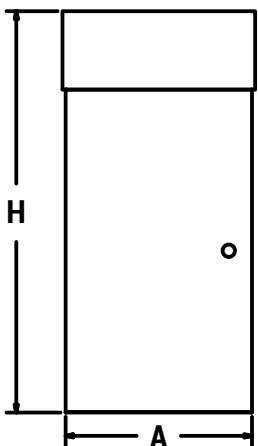
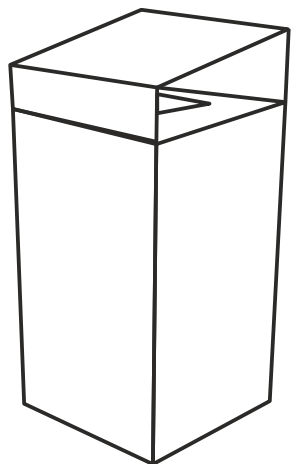

Κωδικός Προϊόντος | Product Code: N108 - 4Κάδοι | 4Bins



Γενικές Διαστάσεις
General Dimensions

	A	B	H	Lt
N108 - 4Κάδοι - 4Bins	1600	400	1000	248
N108 - 1Κάδος - 1Bins	400	1000	62	

*διαστάσεις σε mm *dimensions in mm

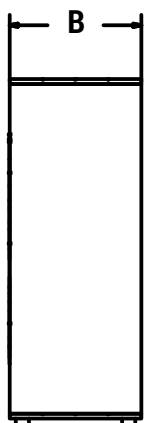
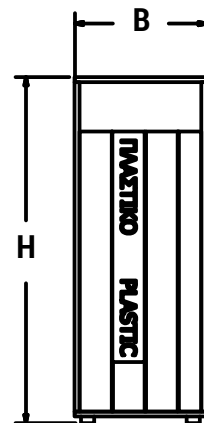
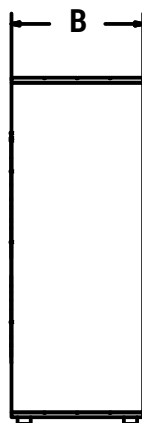
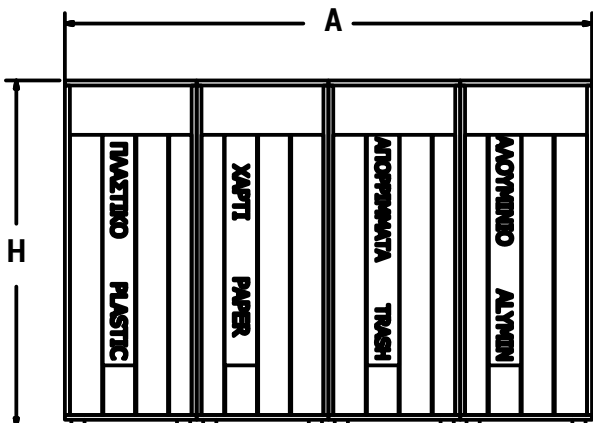
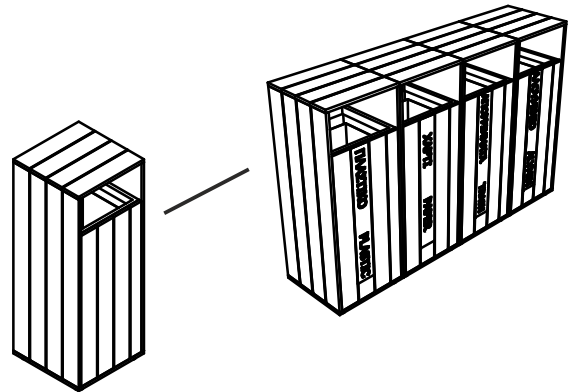



BINS

Wood & Metal

Κωδικός Προϊόντος | Product Code: N128

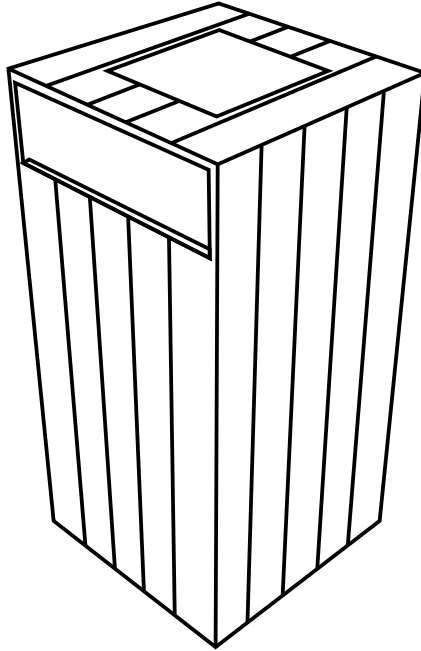

Γενικές Διαστάσεις General Dimensions	A	B	H	Lt
	500	500	1000	162

*διαστάσεις σε mm *dimensions in mm

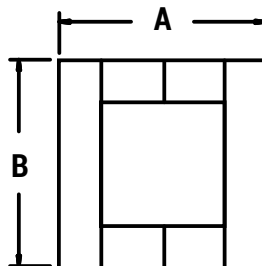
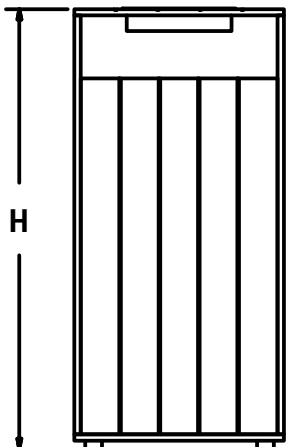

Κωδικός Προϊόντος | Product Code: N117



Γενικές Διαστάσεις
General Dimensions

A	B	H	Lt
450	450	900	122

*διαστάσεις σε mm *dimensions in mm

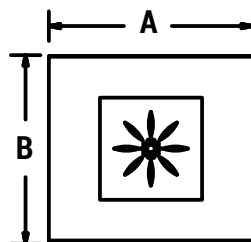
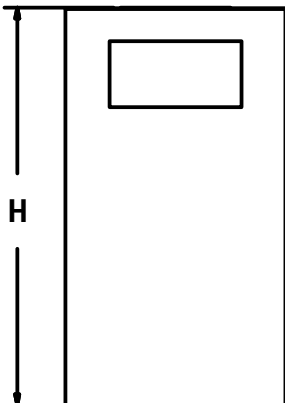
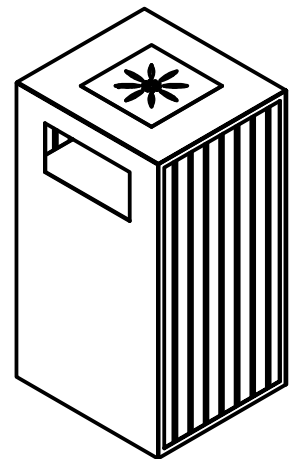

Κωδικός Προϊόντος | Product Code: N100



Γενικές Διαστάσεις
General Dimensions

D	H	H1	Lt
450	918	568	42

*διαστάσεις σε mm *dimensions in mm

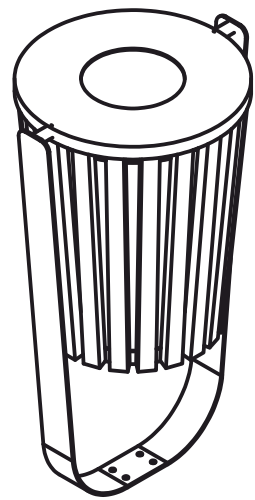
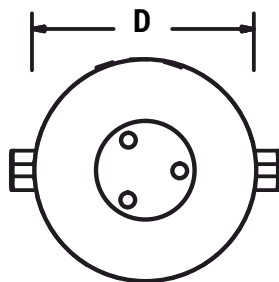
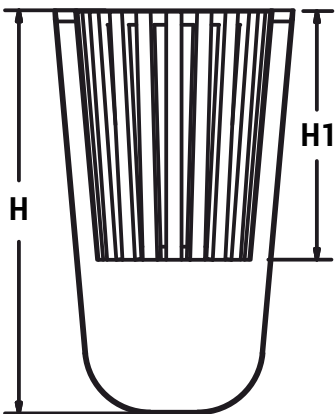

Κωδικός Προϊόντος | Product Code: N87



Γενικές Διαστάσεις
General Dimensions

D	H	Lt
450	650	30

*διαστάσεις σε mm *dimensions in mm

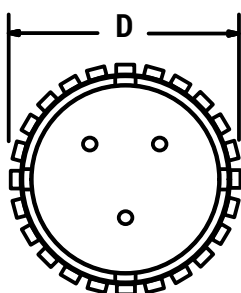
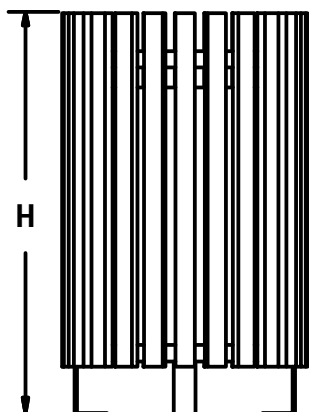
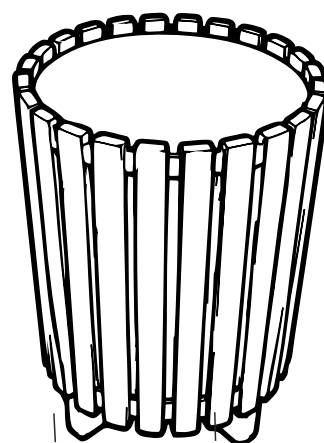

Κωδικός Προϊόντος | Product Code: N43



Γενικές Διαστάσεις
General Dimensions

D	H	H1	Lt
360	850	600	32

*διαστάσεις σε mm *dimensions in mm

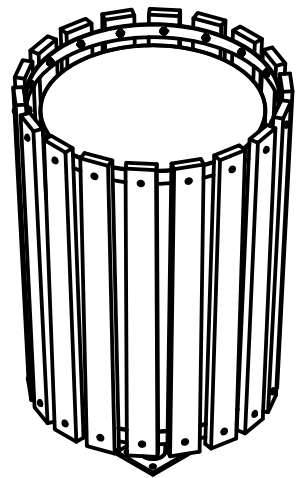
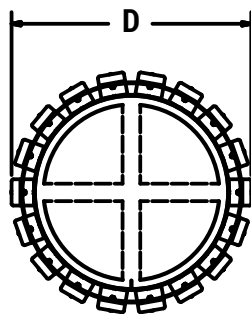
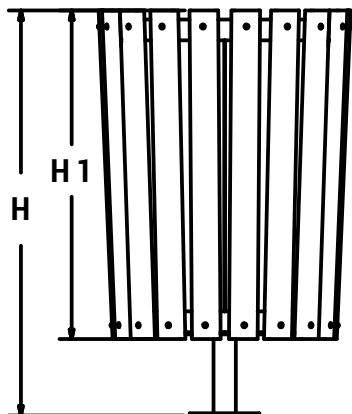

Κωδικός Προϊόντος | Product Code: N56



Γενικές Διαστάσεις
General Dimensions

D	H	H1	Lt
410	840	550	50

*διαστάσεις σε mm *dimensions in mm

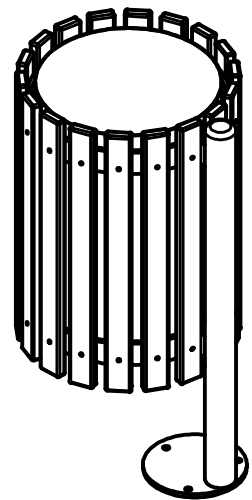
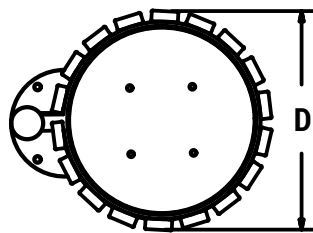
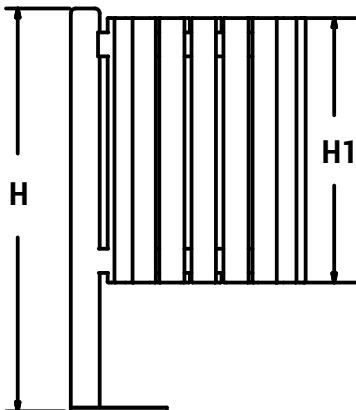

Κωδικός Προϊόντος | Product Code: N49



Γενικές Διαστάσεις
General Dimensions

D	H	H1	Lt
350	900	520	30

*διαστάσεις σε mm *dimensions in mm

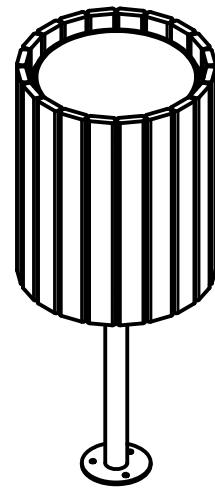
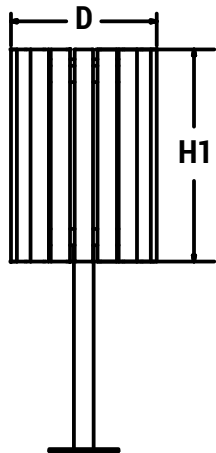

Κωδικός Προϊόντος | Product Code: N27



Γενικές Διαστάσεις
General Dimensions

D	H	H1	Lt
350	970	500	25

*διαστάσεις σε mm *dimensions in mm

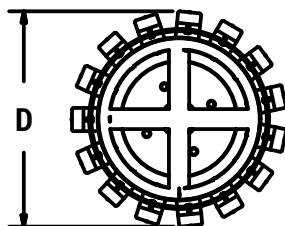
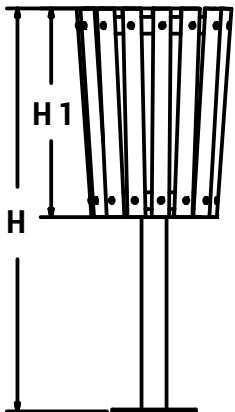
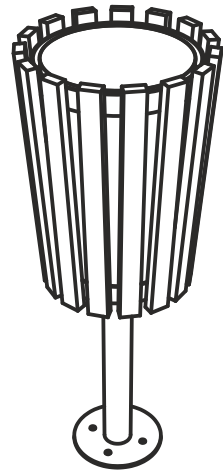

Κωδικός Προϊόντος | Product Code: N57



Γενικές Διαστάσεις
General Dimensions

D	H	Lt
410	1100	40

*διαστάσεις σε mm *dimensions in mm

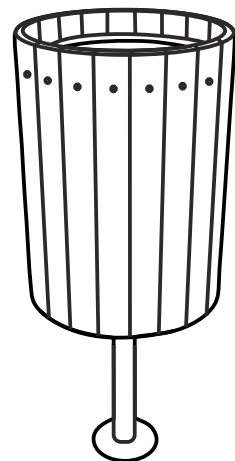
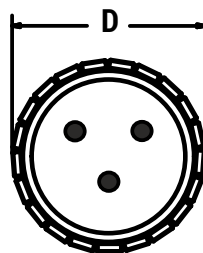

Κωδικός Προϊόντος | Product Code: N45



Γενικές Διαστάσεις
General Dimensions

D	H	H1	Lt
440	1000	820	75

*διαστάσεις σε mm *dimensions in mm

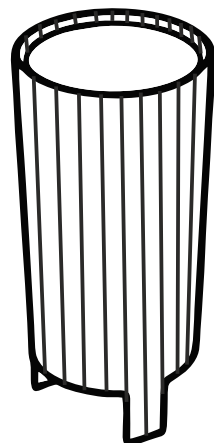
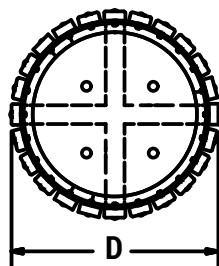
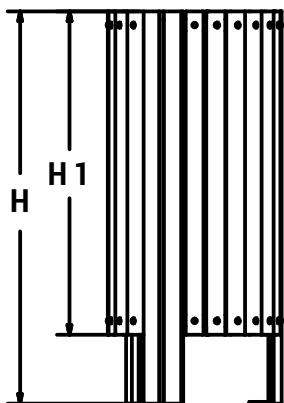

Κωδικός Προϊόντος | Product Code: N52



Γενικές Διαστάσεις
General Dimensions

D	H	H1	Lt
430	930	730	66

*διαστάσεις σε mm *dimensions in mm

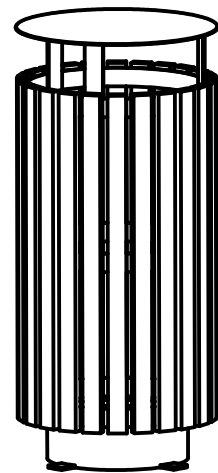
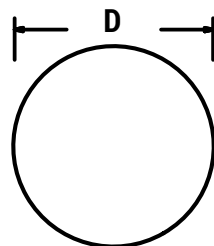
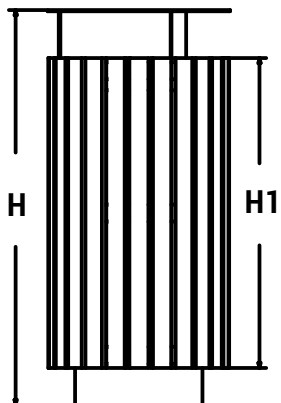

Κωδικός Προϊόντος | Product Code: N129



Γενικές Διαστάσεις
General Dimensions

D	H	Lt
480	800	73

*διαστάσεις σε mm *dimensions in mm

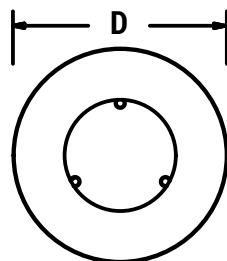
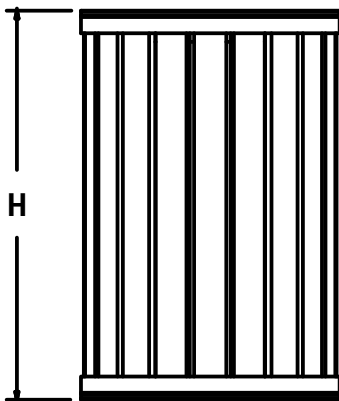
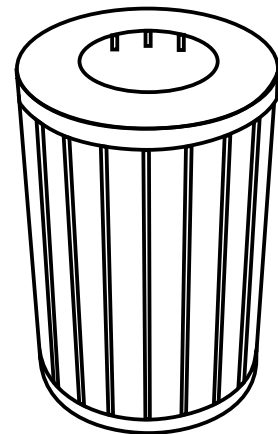

Κωδικός Προϊόντος | Product Code: N53



Γενικές Διαστάσεις
General Dimensions

D	H	Lt
500	940	100

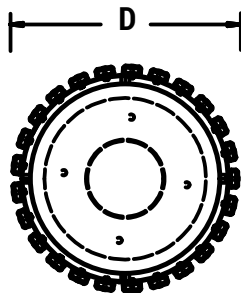
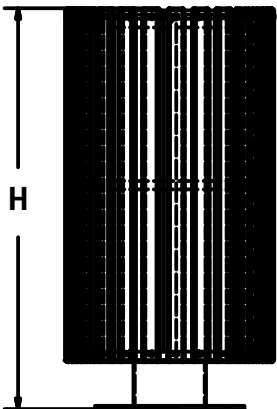
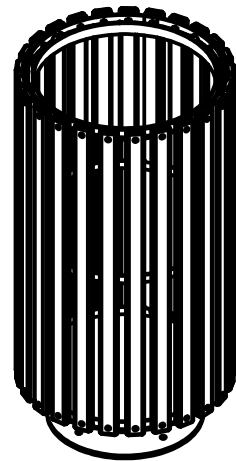

Κωδικός Προϊόντος | Product Code: N64

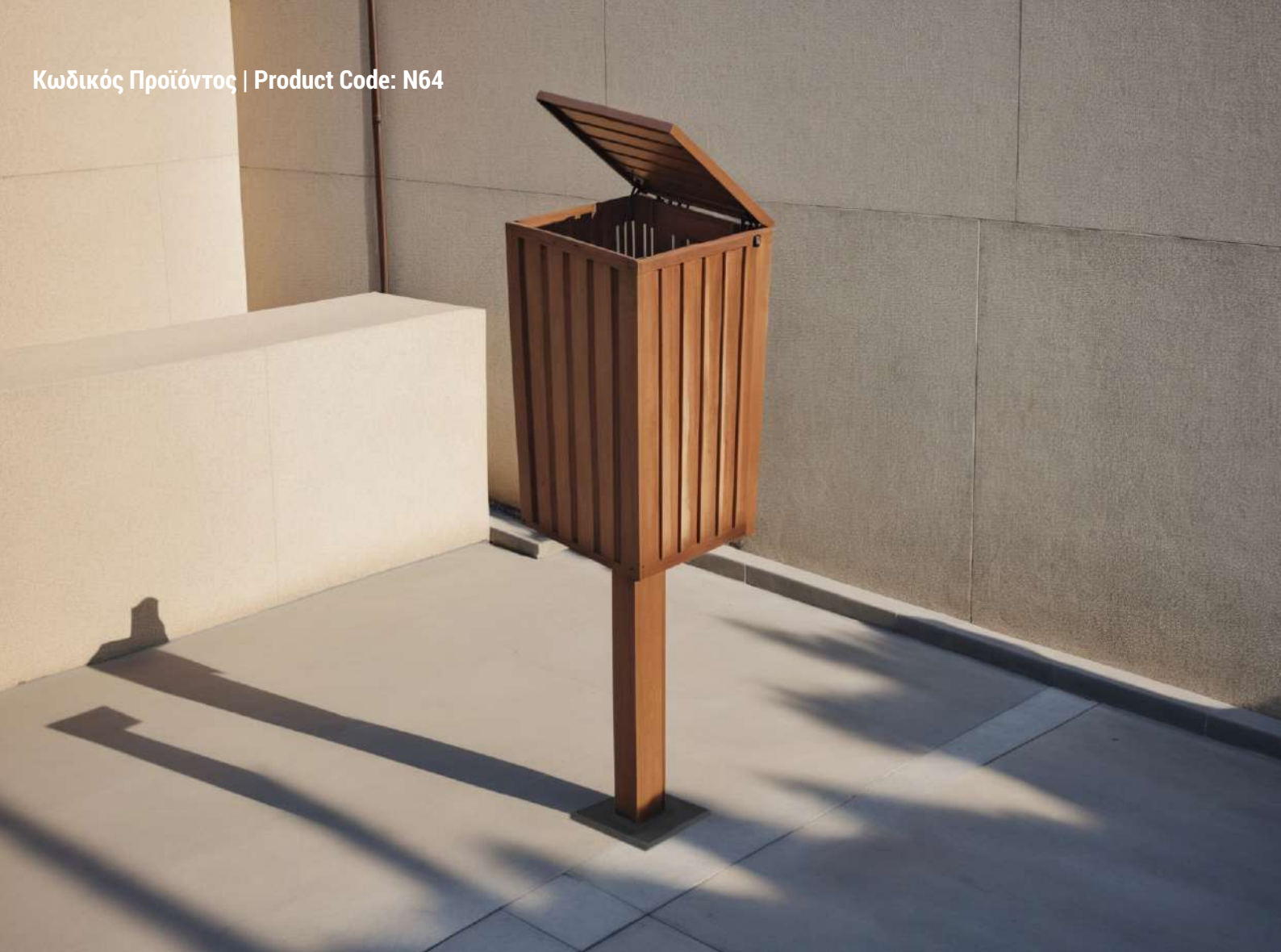

Γενικές Διαστάσεις
General Dimensions

A	B	H	H1	Lt
350	350	1400	630	45

*διαστάσεις σε mm *dimensions in mm

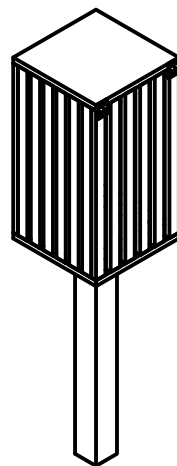
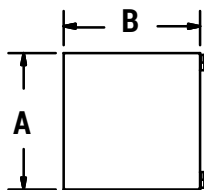
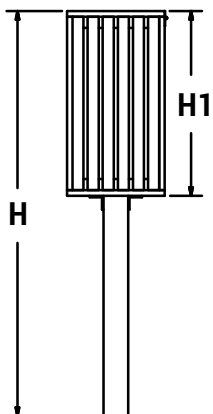

Κωδικός Προϊόντος | Product Code: N67-2



Γενικές Διαστάσεις
General Dimensions

A	B	H	Lt
350	300	1000	38

*διαστάσεις σε mm *dimensions in mm

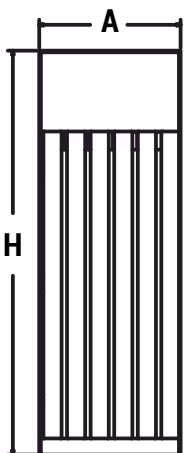
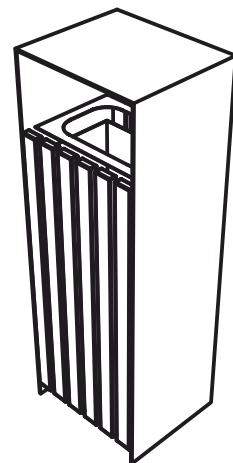

Κωδικός Προϊόντος | Product Code: N83



Γενικές Διαστάσεις
General Dimensions

A	B	H	Lt
400	400	800	80

*διαστάσεις σε mm *dimensions in mm

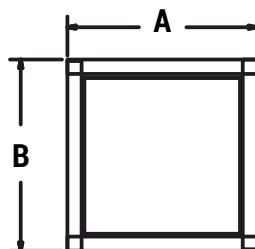
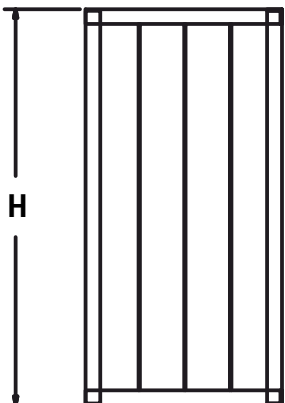
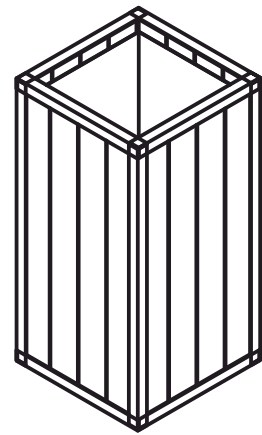

Κωδικός Προϊόντος | Product Code: N86



Γενικές Διαστάσεις
General Dimensions

A	B	H	H1	Lt
520	520	920	750	65

*διαστάσεις σε mm *dimensions in mm

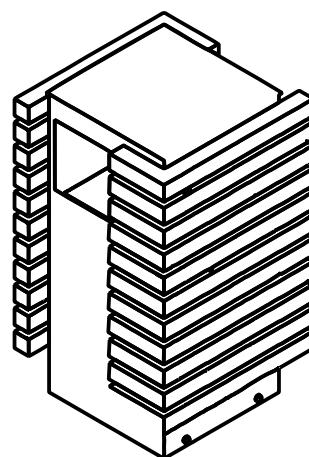
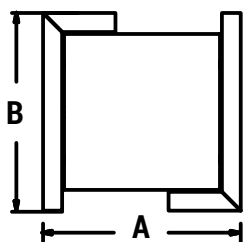
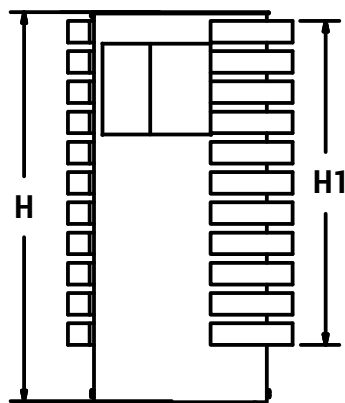

Κωδικός Προϊόντος | Product Code: N141



Γενικές Διαστάσεις
General Dimensions

H	H1	A	B	Lt
400	800	500	500	39

*διαστάσεις σε mm *dimensions in mm

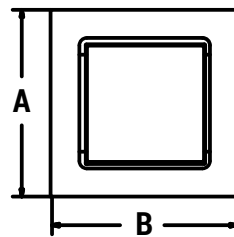
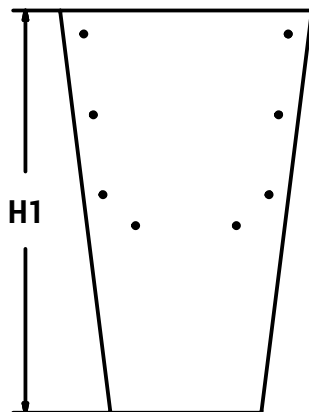
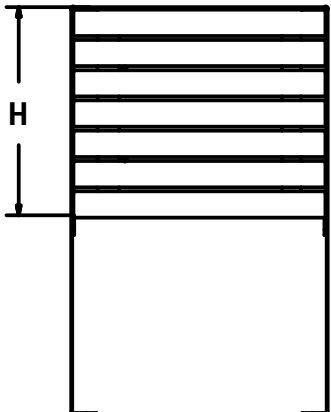
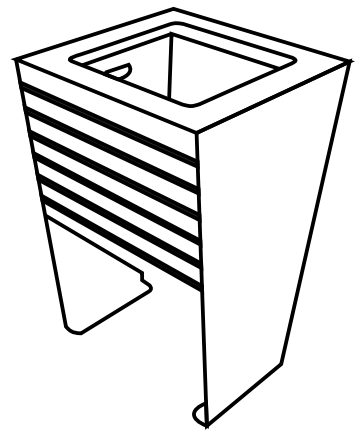

Κωδικός Προϊόντος | Product Code: N127



Γενικές Διαστάσεις
General Dimensions

A	B	H	Lt
420	420	700	61

*διαστάσεις σε mm *dimensions in mm

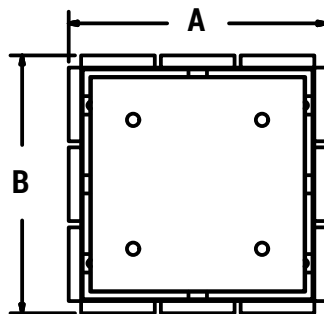
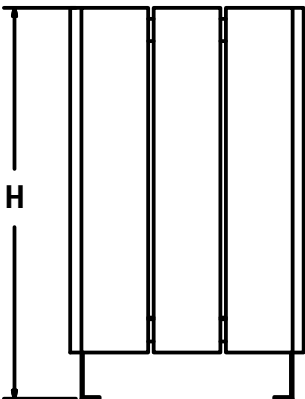
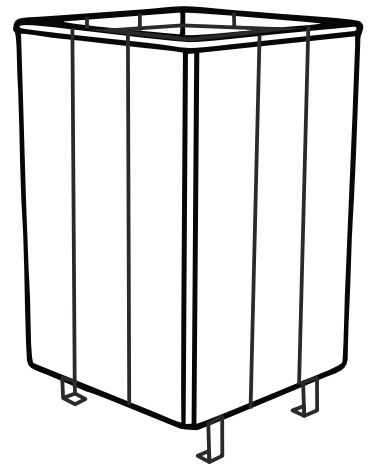



CONCRETE BIN

Κωδικός Προϊόντος | Product Code: N39

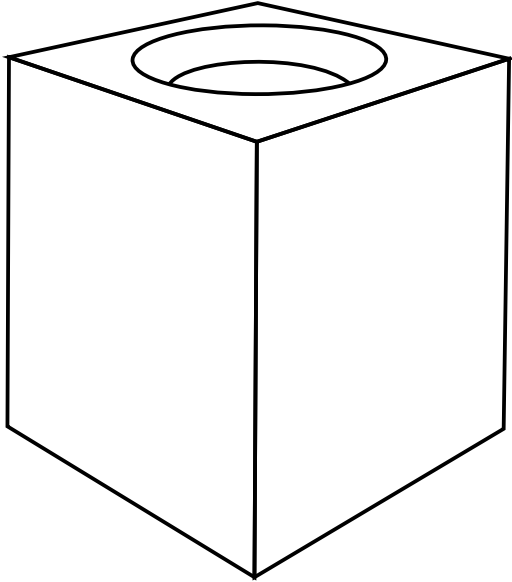

Γενικές Διαστάσεις
General Dimensions

A	B	H1	H2	Lt	W
600	600	720	400	75	550

*διαστάσεις σε mm *dimensions in mm

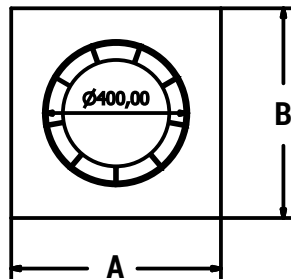
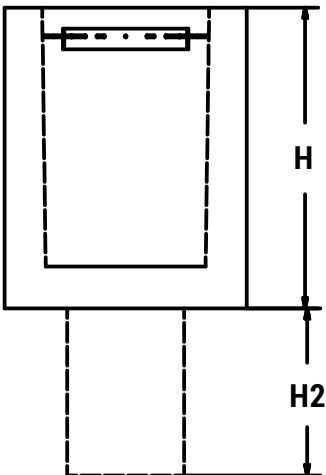



BIN ENCLOSURES

Κωδικός Προϊόντος | Product Code: K016

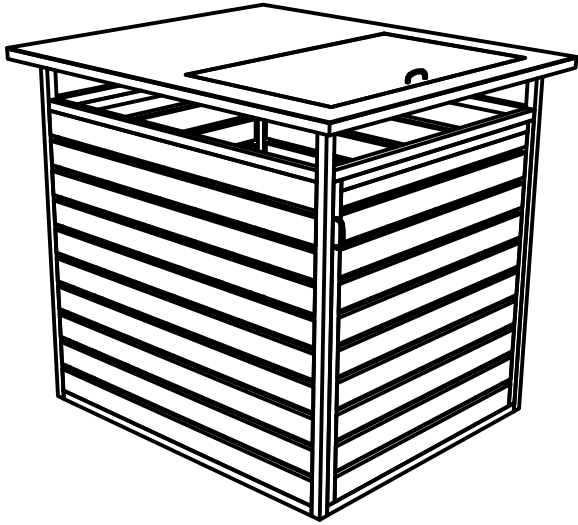

Γενικές Διαστάσεις
General Dimensions

A	B	H
1680	1450	1500

*διαστάσεις σε mm *dimensions in mm

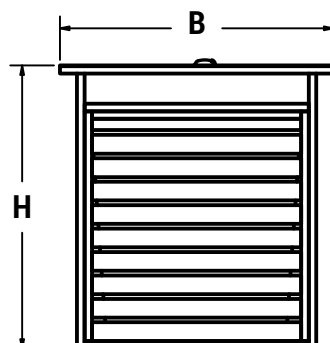
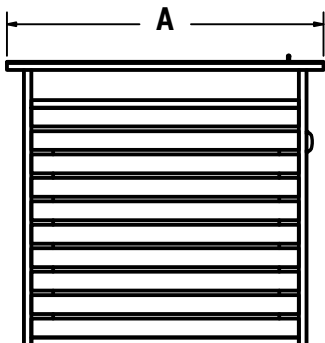

Κωδικός Προϊόντος | Product Code: KA010



Γενικές Διαστάσεις
General Dimensions

A	B	H
2500	1500	1500

*διαστάσεις σε mm *dimensions in mm

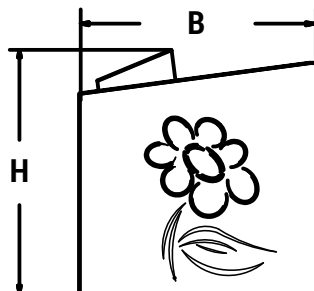
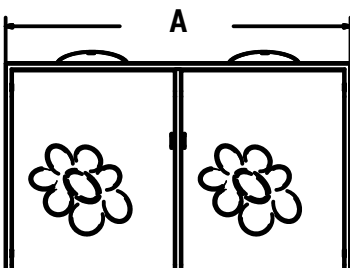
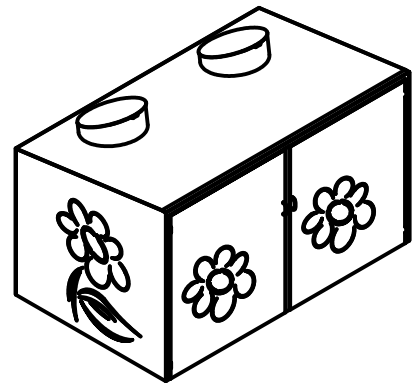

Κωδικός Προϊόντος | Product Code: ΚΑ09



Γενικές Διαστάσεις
General Dimensions

A	B	H
3000	1280	1800

*διαστάσεις σε mm *dimensions in mm

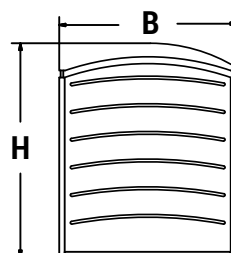
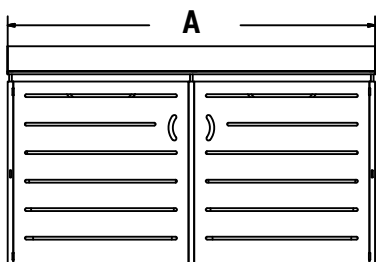
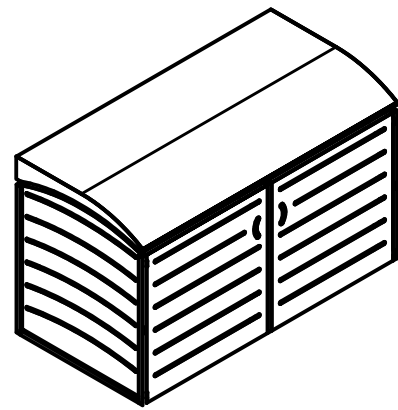

Κωδικός Προϊόντος | Product Code: KA015



Γενικές Διαστάσεις
General Dimensions

A	B	H
1545	1275	1585

*διαστάσεις σε mm *dimensions in mm

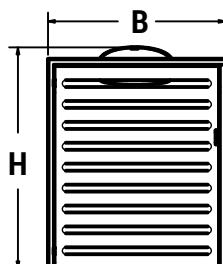
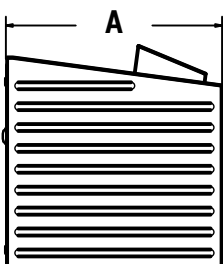
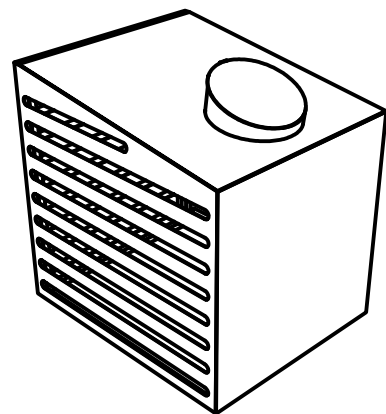



URBAN POT

Wood & Metal

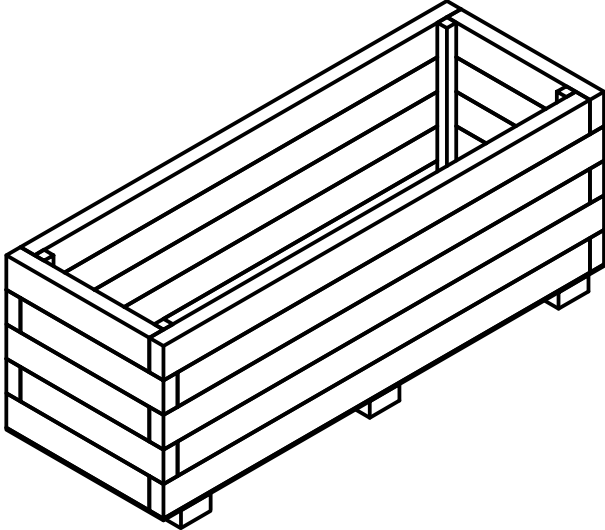

Γενικές Διαστάσεις General Dimensions	A	B	H
	1400	500	480

*διαστάσεις σε mm *dimensions in mm

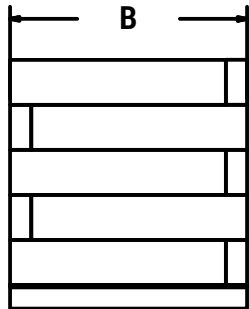
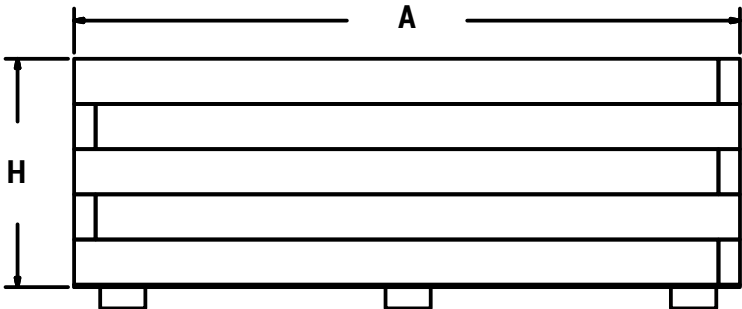

Κωδικός Προϊόντος | Product Code: GL033



Κωδικός Προϊόντος | Product Code: GL031

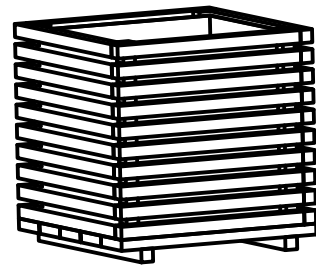
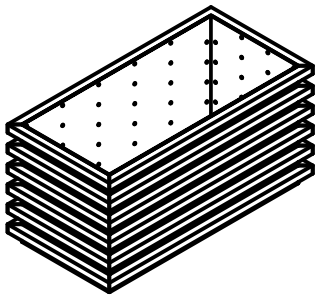

Γενικές Διαστάσεις
General Dimensions

A	B	H
1000	500	500

Γενικές Διαστάσεις
General Dimensions

A	B	H
500	500	500

*διαστάσεις σε mm *dimensions in mm

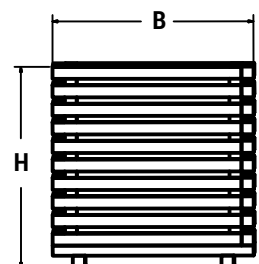
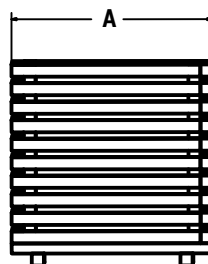
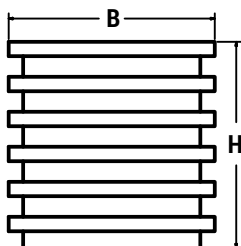
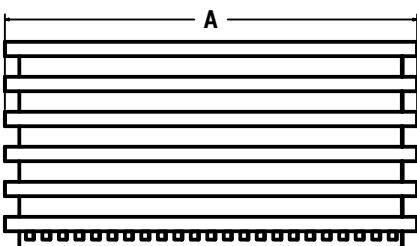

Κωδικός Προϊόντος | Product Code: GL039



Γενικές Διαστάσεις
General Dimensions

D

H

950

500

*διαστάσεις σε mm *dimensions in mm

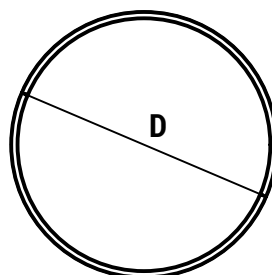
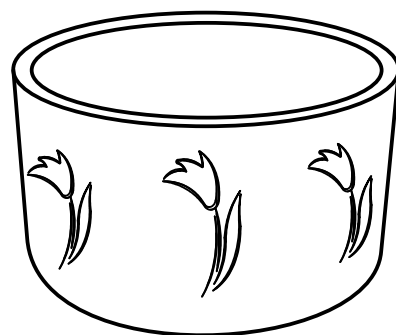

Κωδικός Προϊόντος | Product Code: GL041



Γενικές Διαστάσεις
General Dimensions

A	B	H
1500	500	500

*διαστάσεις σε mm *dimensions in mm

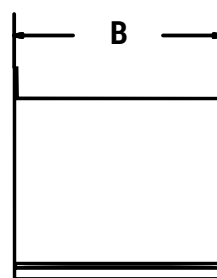
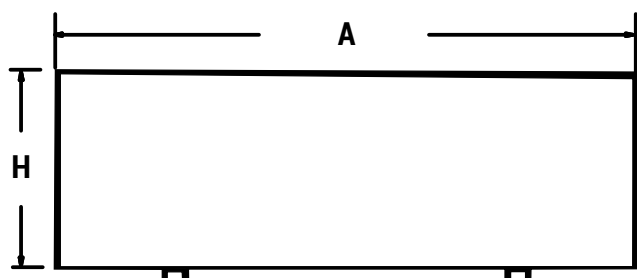
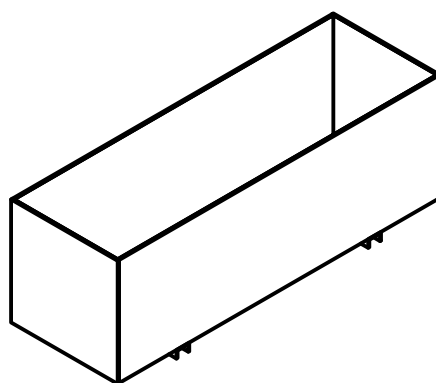

Κωδικός Προϊόντος | Product Code: GL011



Γενικές Διαστάσεις
General Dimensions

A	B	H
1000	480	460

*διαστάσεις σε mm *dimensions in mm

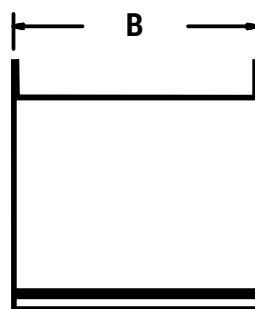
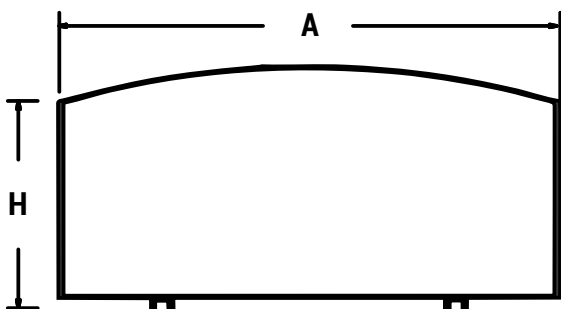
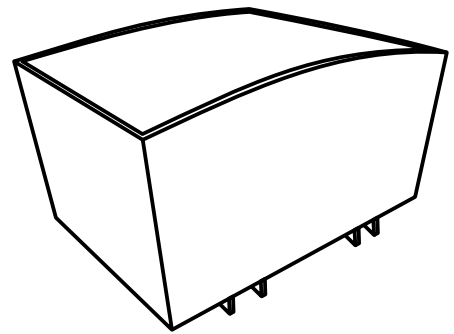



Γενικές Διαστάσεις
General Dimensions

A	B	H
1500	500	500

*διαστάσεις σε mm *dimensions in mm

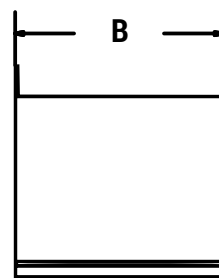
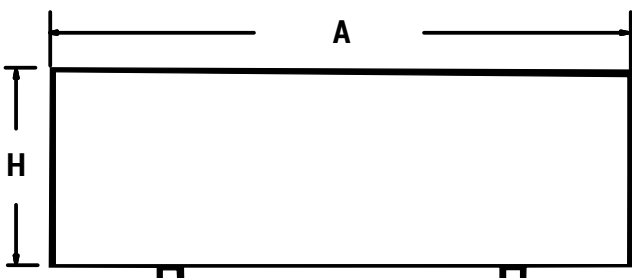
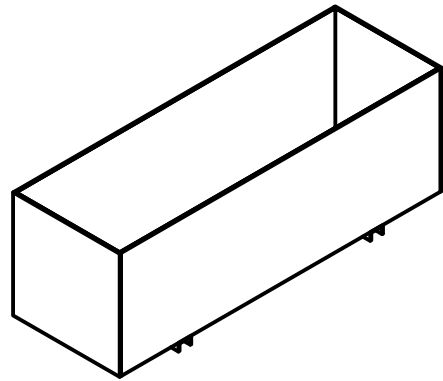



Γενικές Διαστάσεις
General Dimensions

A	B	H
1100	950	500

*διαστάσεις σε mm *dimensions in mm

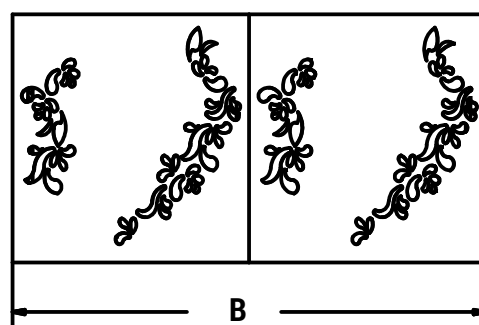
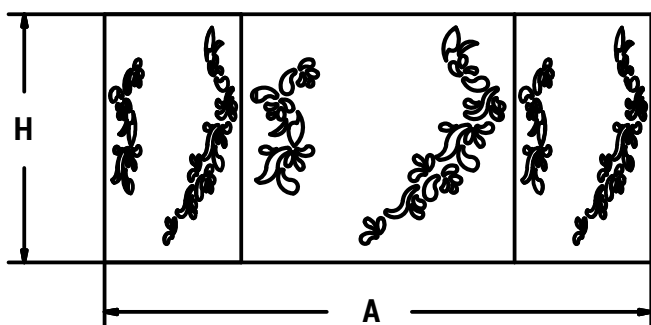
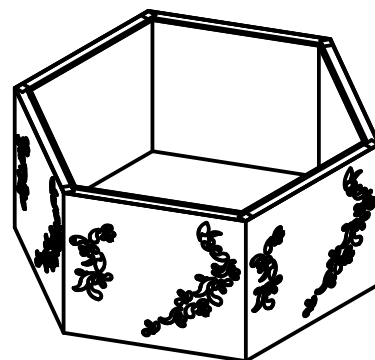



TREE GRADES

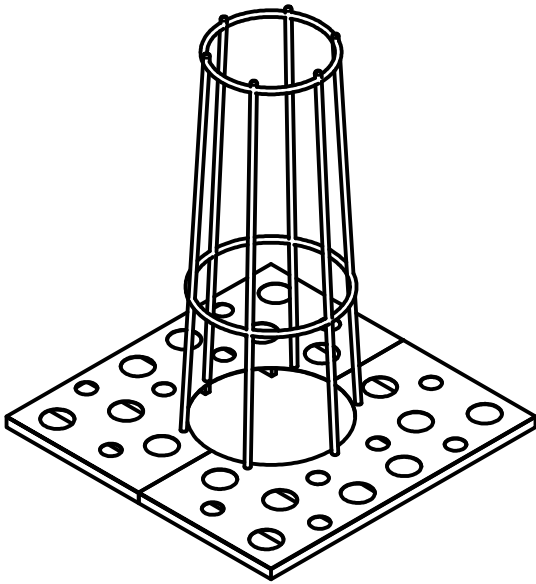

Γενικές Διαστάσεις General Dimensions	A	B	H	D
	1000	1000	1200	540

*διαστάσεις σε mm *dimensions in mm

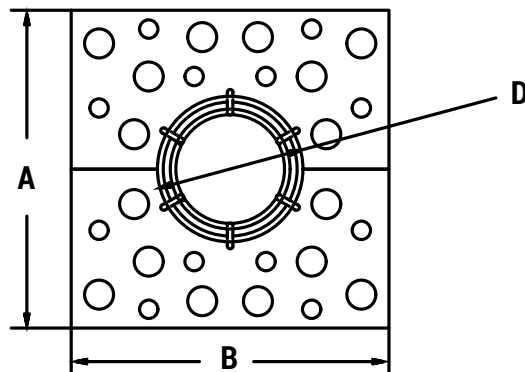
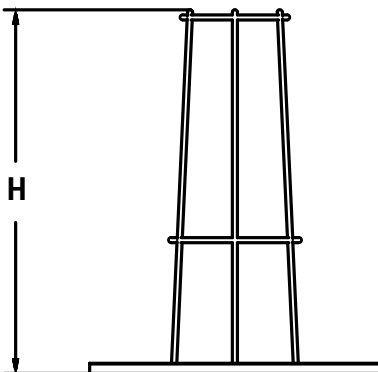

Κωδικός Προϊόντος | Product Code: SH41-1



Γενικές Διαστάσεις
General Dimensions

A	B	D	H
1000	1000	400	33

*διαστάσεις σε mm *dimensions in mm

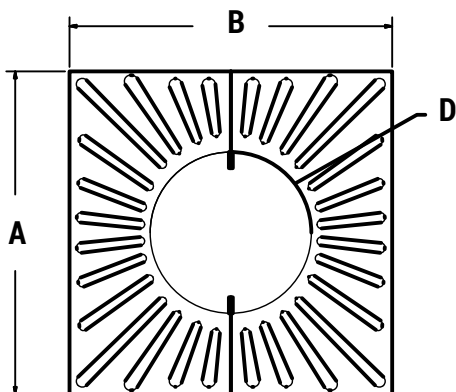
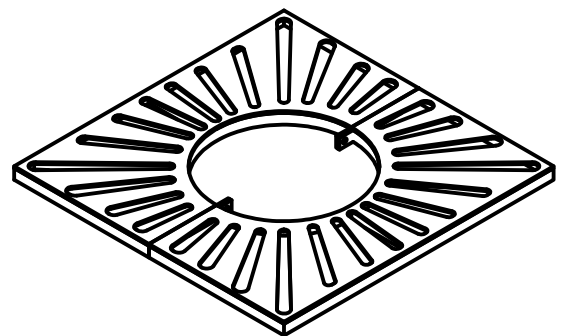

Κωδικός Προϊόντος | Product Code: SH014



Γενικές Διαστάσεις
General Dimensions

A	B	D	H
2000	2000	600	33

*διαστάσεις σε mm *dimensions in mm

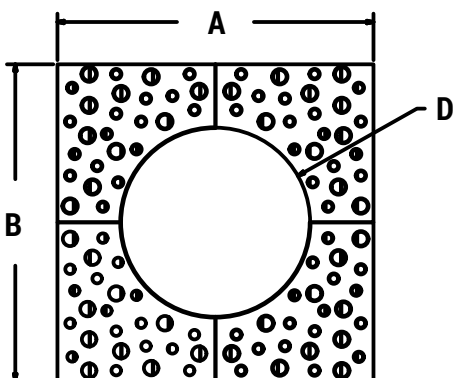
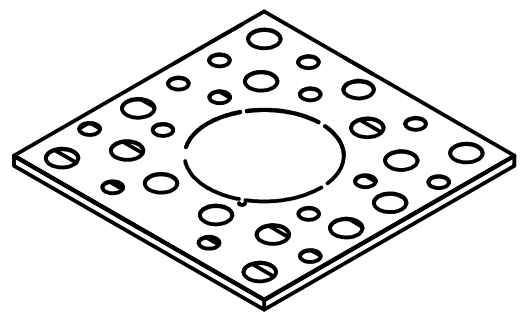

Κωδικός Προϊόντος | Product Code: SH011



Γενικές Διαστάσεις
General Dimensions

A	B	H	D
1000	1000	33	300

*διαστάσεις σε mm *dimensions in mm

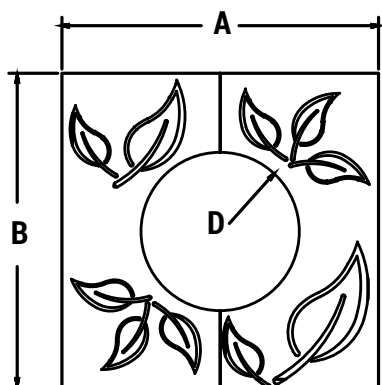
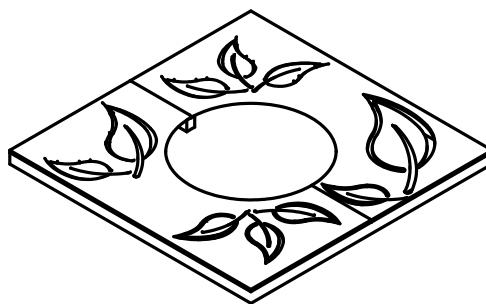

Κωδικός Προϊόντος | Product Code: SH003

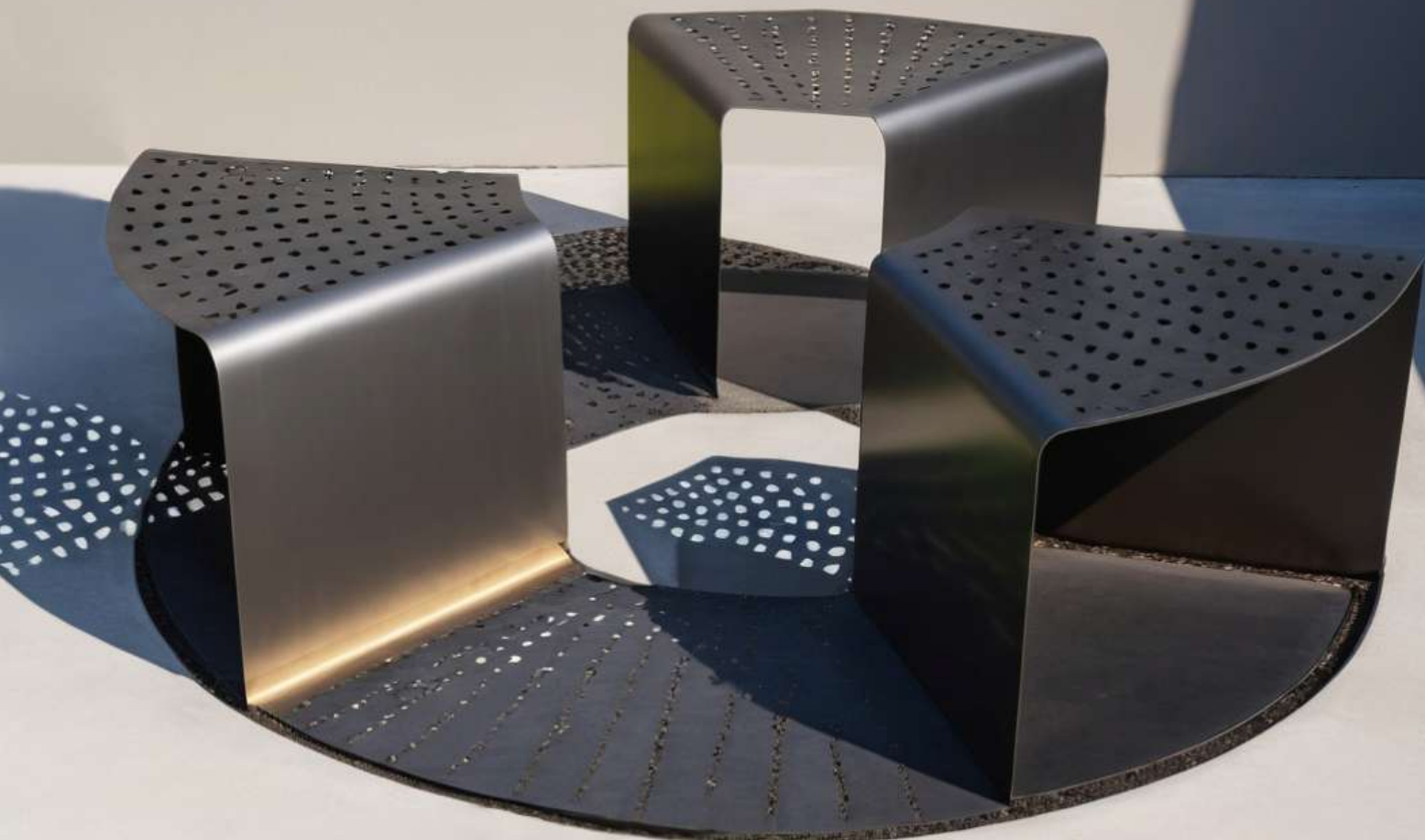

Γενικές Διαστάσεις
General Dimensions

D

H

1600

450

*διαστάσεις σε mm *dimensions in mm

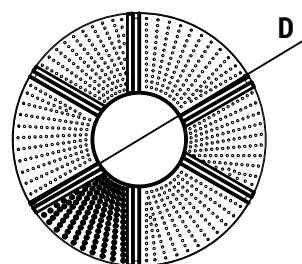
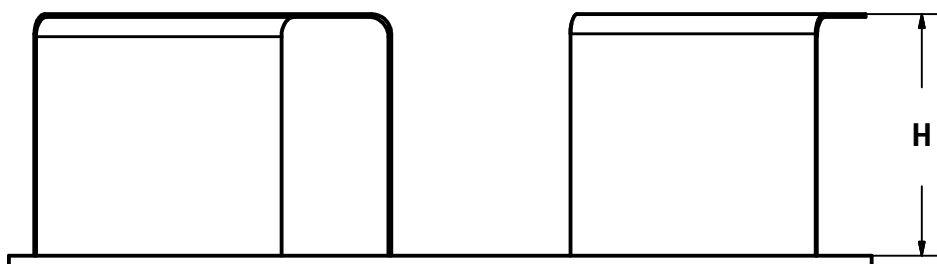
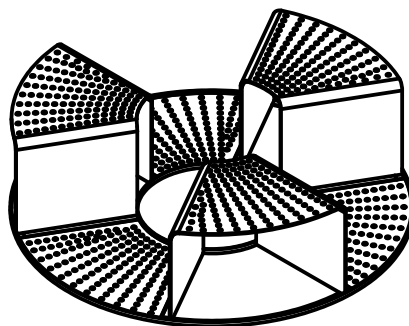

Κωδικός Προϊόντος | Product Code: SH005



Γενικές Διαστάσεις
General Dimensions

D

H

800

400

*διαστάσεις σε mm *dimensions in mm

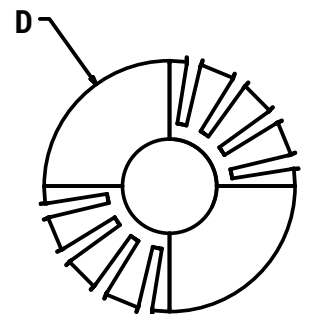
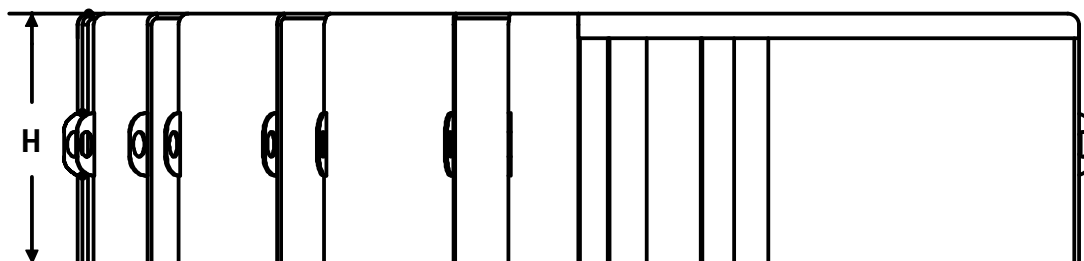
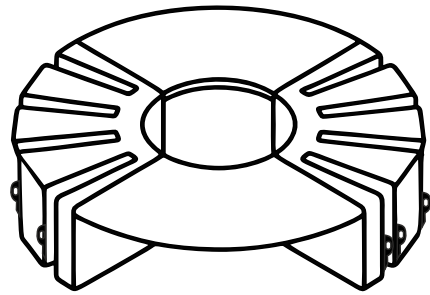



WATER TAP

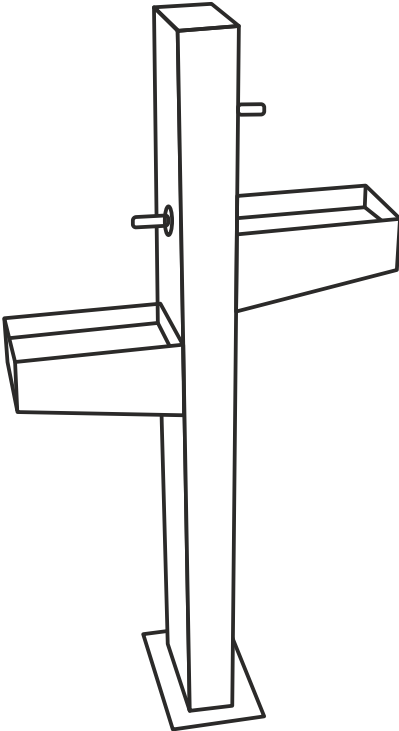

Γενικές Διαστάσεις General Dimensions	A	B	H
	750	300	1200

*διαστάσεις σε mm *dimensions in mm

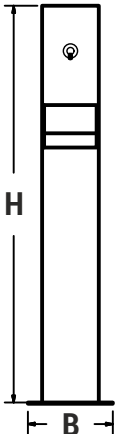
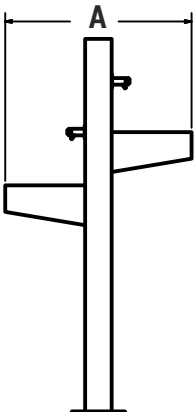

Κωδικός Προϊόντος | Product Code: KR004



Γενικές Διαστάσεις
General Dimensions

A	B	H
1000	1000	1100

*διαστάσεις σε mm *dimensions in mm

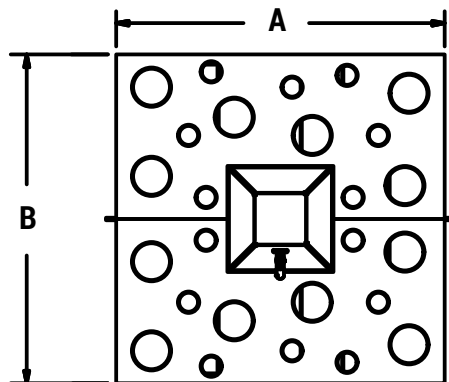
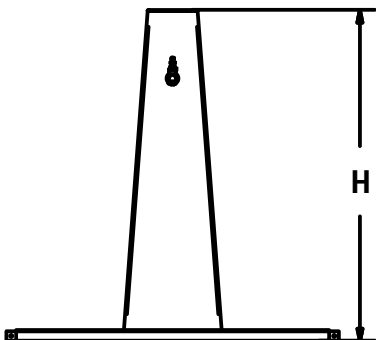
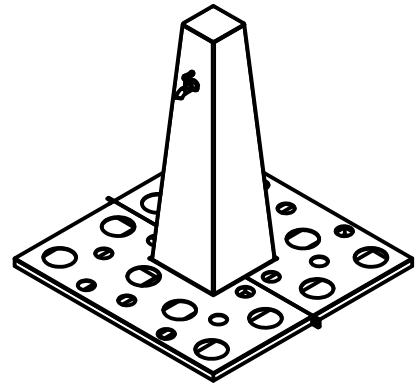

Κωδικός Προϊόντος | Product Code: KR012



Γενικές Διαστάσεις
General Dimensions

A	B	H
655	410	810

*διαστάσεις σε mm *dimensions in mm

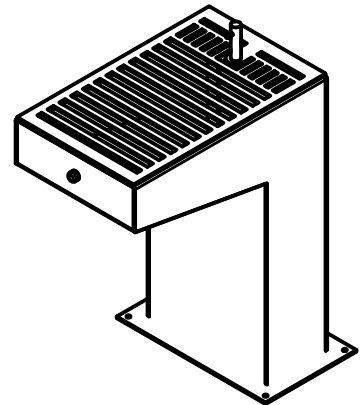
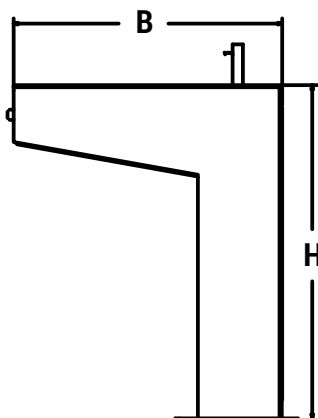
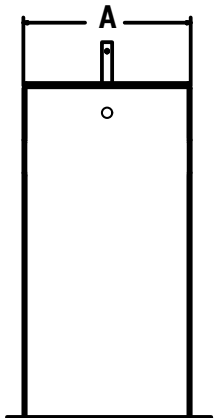

Κωδικός Προϊόντος | Product Code: KR003



Γενικές Διαστάσεις
General Dimensions

D	B	H
400	200	1000

*διαστάσεις σε mm *dimensions in mm

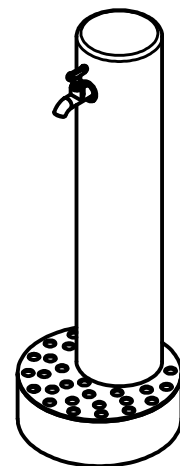
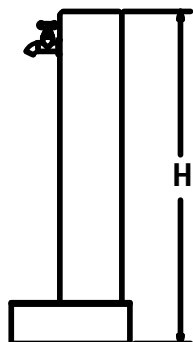
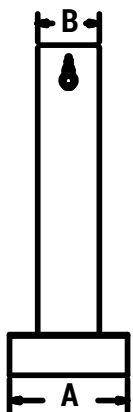

Κωδικός Προϊόντος | Product Code: KR007



Γενικές Διαστάσεις
General Dimensions

A	B	H
620	550	1000

*διαστάσεις σε mm *dimensions in mm

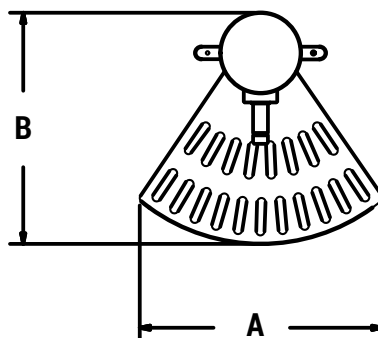
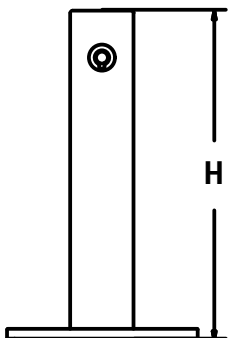
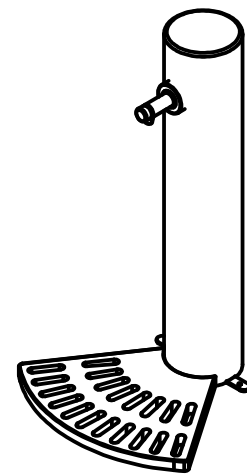

Κωδικός Προϊόντος | Product Code: KR005



Γενικές Διαστάσεις
General Dimensions

A	B	H
580	335	1000

*διαστάσεις σε mm *dimensions in mm

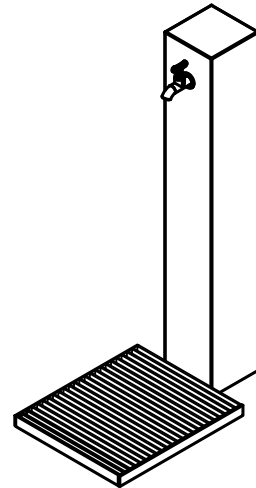
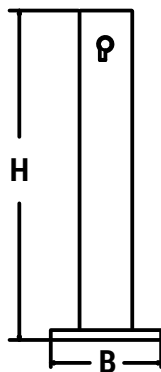
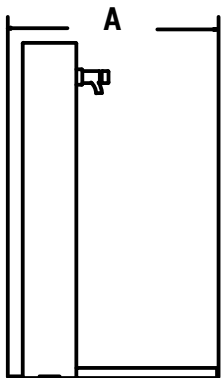

Κωδικός Προϊόντος | Product Code: KR005 -1



Γενικές Διαστάσεις
General Dimensions

A	B	H
1000	355	1000

*διαστάσεις σε mm *dimensions in mm

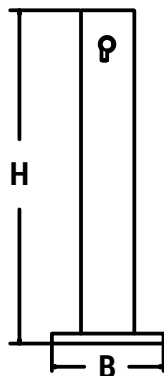
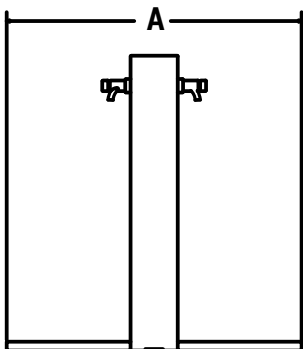
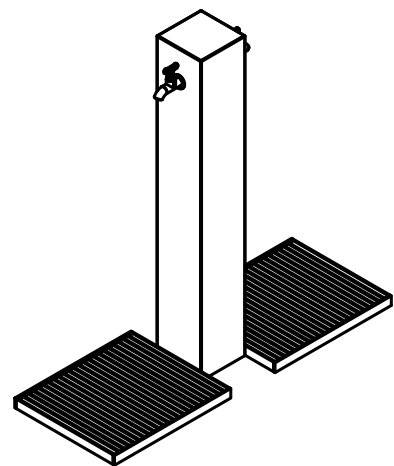

Κωδικός Προϊόντος | Product Code: KR010



Γενικές Διαστάσεις
General Dimensions

A	B	H
300	900	1050

*διαστάσεις σε mm *dimensions in mm

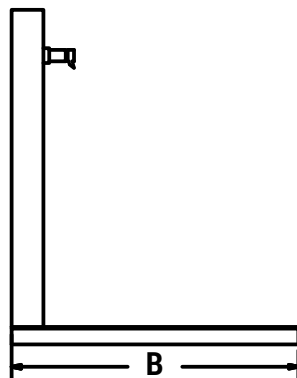
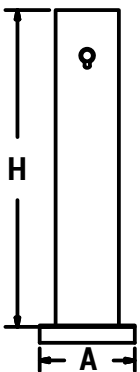
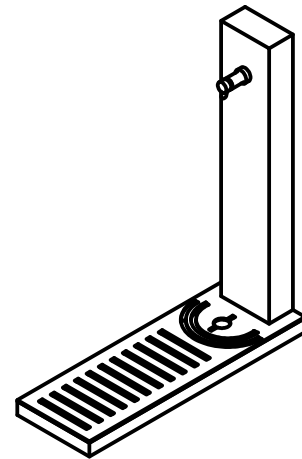

Κωδικός Προϊόντος | Product Code: KR006



Γενικές Διαστάσεις
General Dimensions

A	B	H
470	500	900

*διαστάσεις σε mm *dimensions in mm

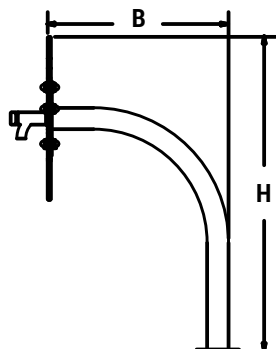
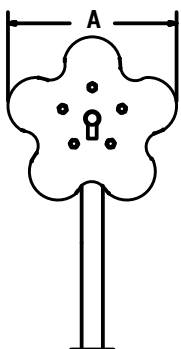
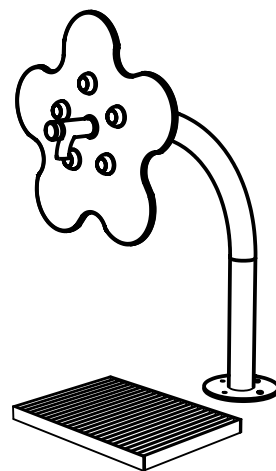



BUS SHELTER

Κωδικός Προϊόντος | Product Code: N20 - B

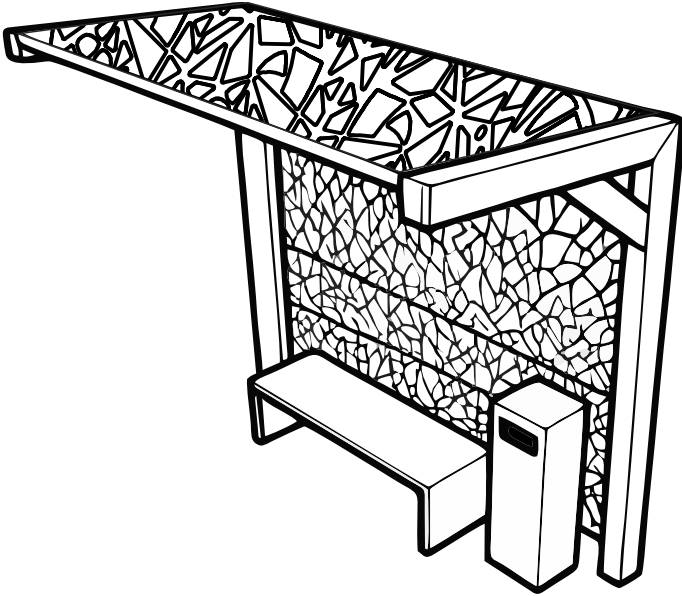

Γενικές Διαστάσεις
General Dimensions

A	B	H
3000	1500	2550

*διαστάσεις σε mm *dimensions in mm

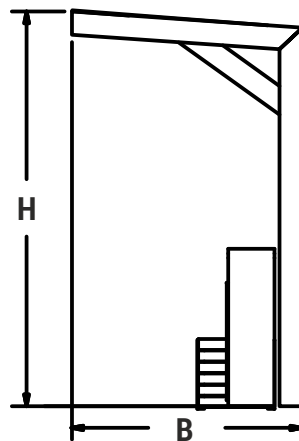
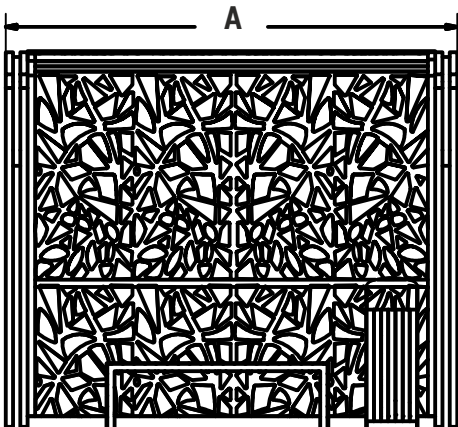

Κωδικός Προϊόντος | Product Code: N11

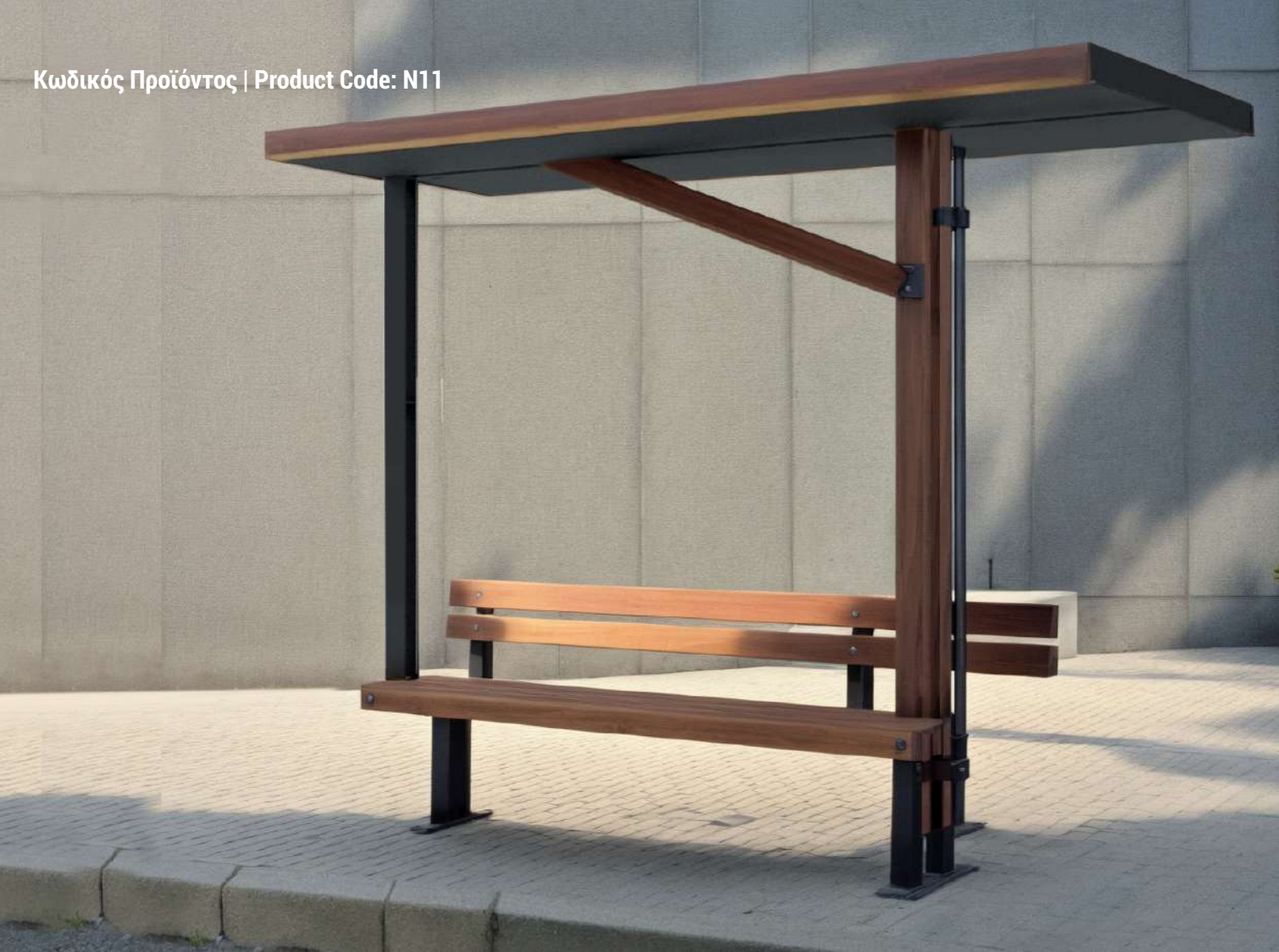

Γενικές Διαστάσεις
General Dimensions

A	B	H
3600	1420	2860

*διαστάσεις σε mm *dimensions in mm

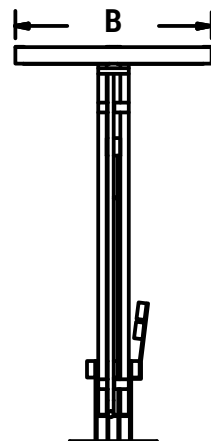
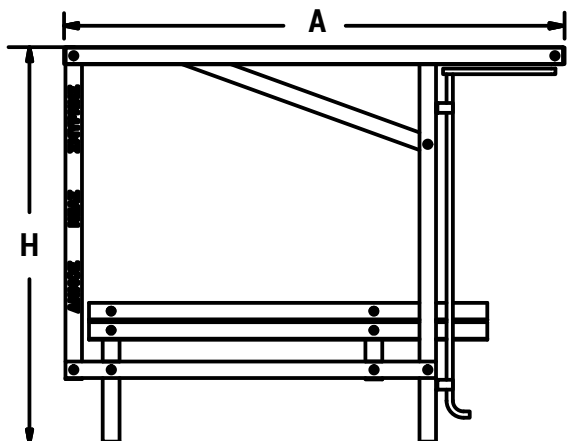

Κωδικός Προϊόντος | Product Code: N9



Γενικές Διαστάσεις
General Dimensions

A	B	H
3000	1250	2300

*διαστάσεις σε mm *dimensions in mm

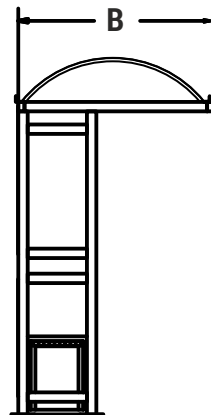
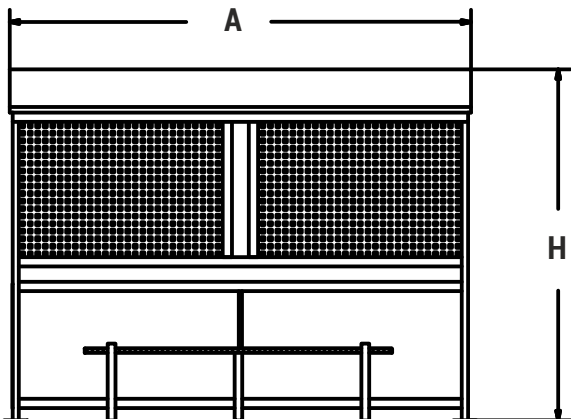
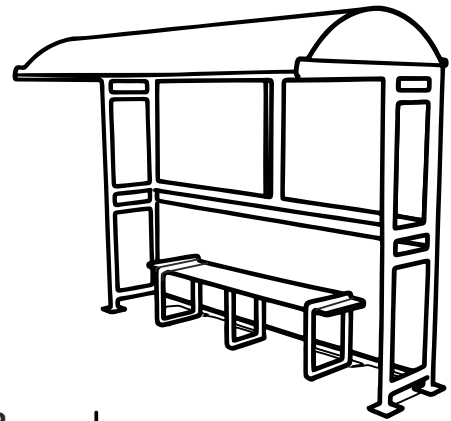

Κωδικός Προϊόντος | Product Code: N19



Γενικές Διαστάσεις
General Dimensions

A	B	H
4000	1600	2600

*διαστάσεις σε mm *dimensions in mm

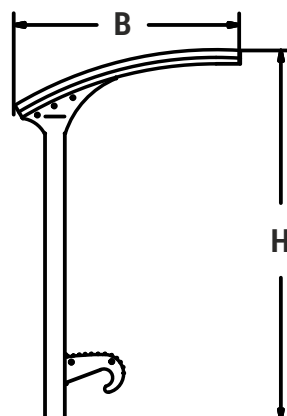
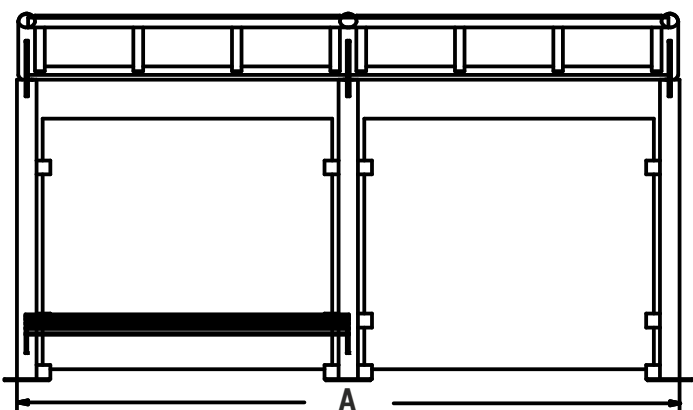
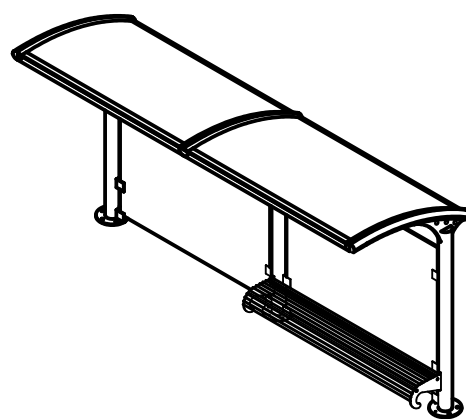

Κωδικός Προϊόντος | Product Code: F05-A



Γενικές Διαστάσεις
General Dimensions

A	B	H
4000	1200	2647

*διαστάσεις σε mm *dimensions in mm

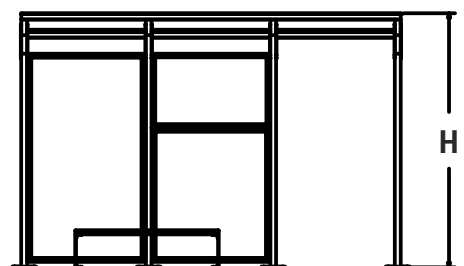
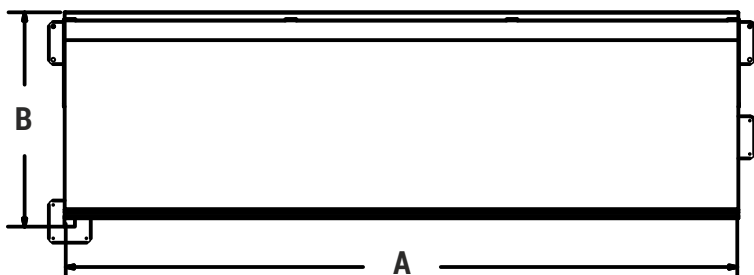
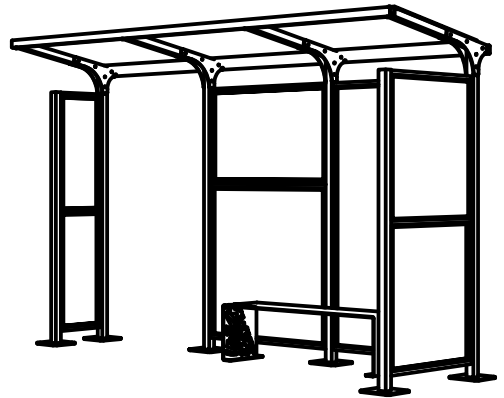

Κωδικός Προϊόντος | Product Code: F05-B



Γενικές Διαστάσεις
General Dimensions

A	B	H
4000	1190	2647

*διαστάσεις σε mm *dimensions in mm

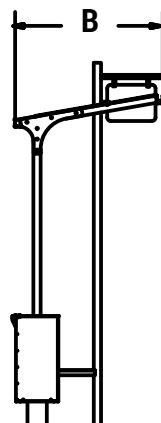
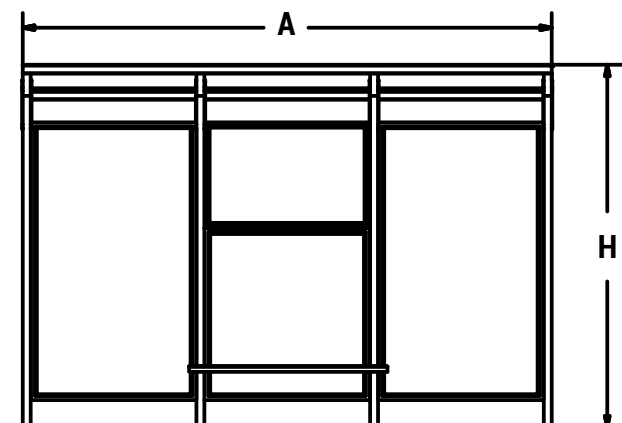
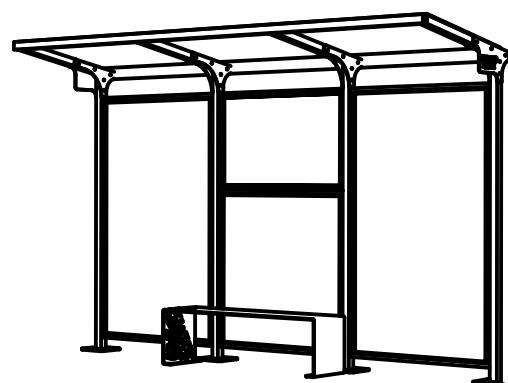

Κωδικός Προϊόντος | Product Code: F05-B



Γενικές Διαστάσεις
General Dimensions

A	B	H
4000	1200	2647

*διαστάσεις σε mm *dimensions in mm

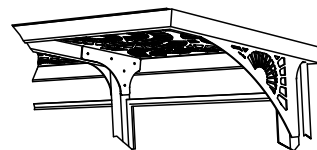
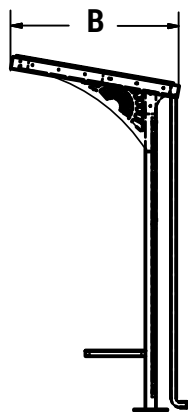
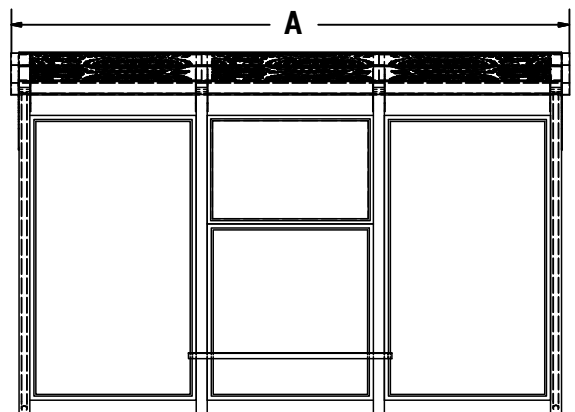
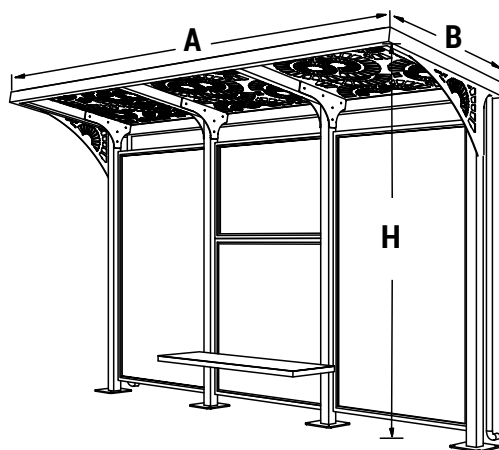



BIKE RACK

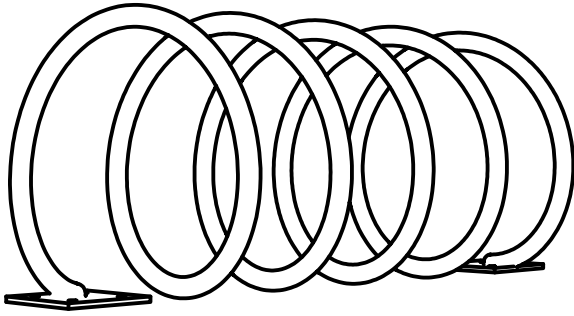

Γενικές Διαστάσεις General Dimensions	K13-1	A	B	D	F
		1000	4 θέσεων	450	33.7
Γενικές Διαστάσεις General Dimensions	K13-2	A	B	D	F
	1500	5 θέσεων	450	33.7	
Γενικές Διαστάσεις General Dimensions	K13-3	A	B	D	F
	2000	10 θέσεων	450	33.7	

*διαστάσεις σε mm *dimensions in mm

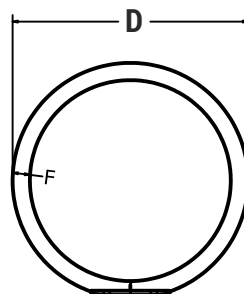
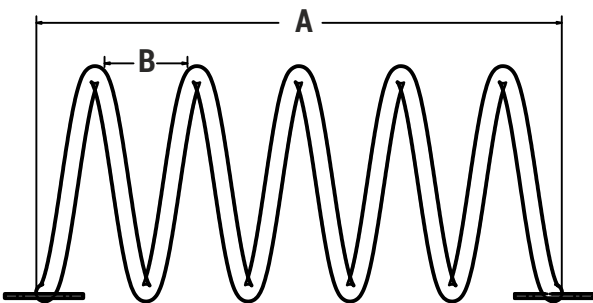

Κωδικός Προϊόντος | Product Code: K15



Γενικές Διαστάσεις
General Dimensions

A	B	H
2600	330	610

*διαστάσεις σε mm *dimensions in mm

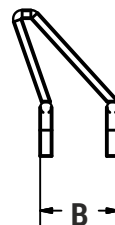
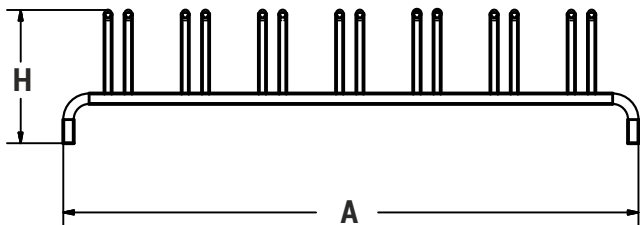
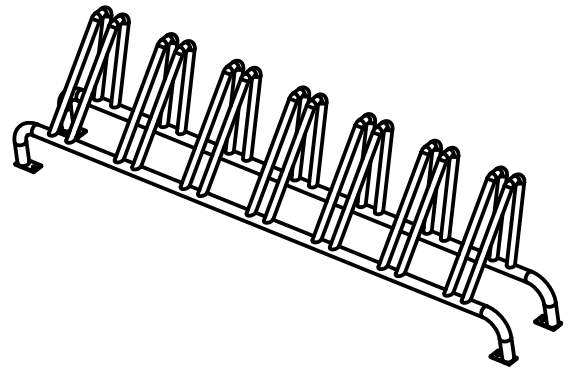

Κωδικός Προϊόντος | Product Code: BCS30 40



Κωδικός Προϊόντος | Product Code: BCS30 60

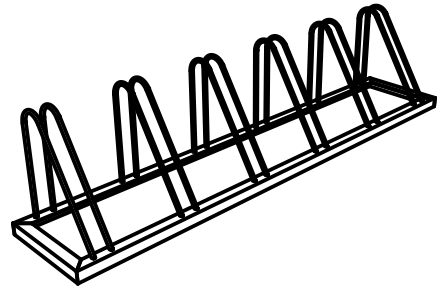
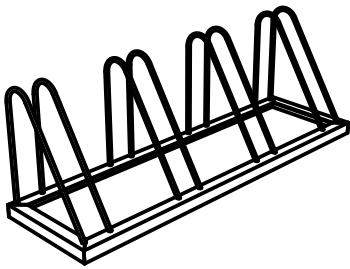

Γενικές Διαστάσεις
General Dimensions

A	B	H
1200	350	410

Γενικές Διαστάσεις
General Dimensions

A	B	H
1800	350	410

*διαστάσεις σε mm *dimensions in mm

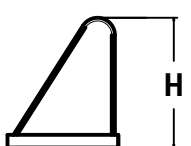
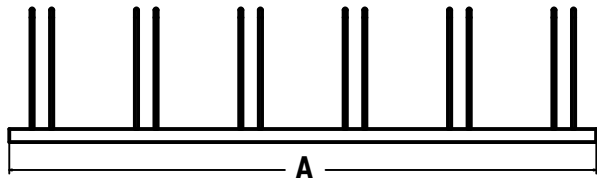
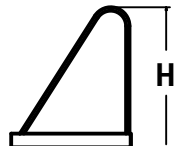
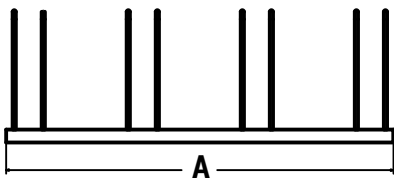
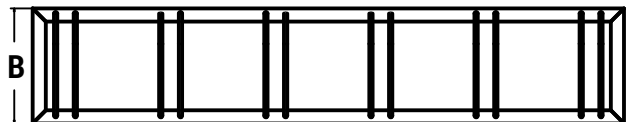
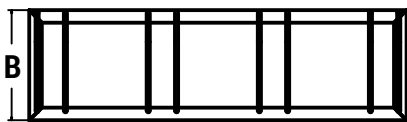

Κωδικός Προϊόντος | Product Code: K2

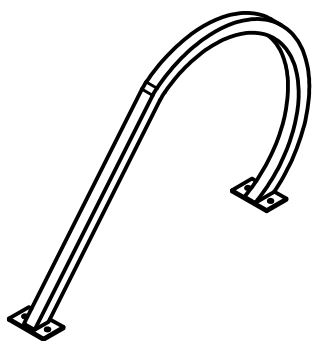

Γενικές Διαστάσεις
General Dimensions

A	B	H
1350	200	750

*διαστάσεις σε mm *dimensions in mm

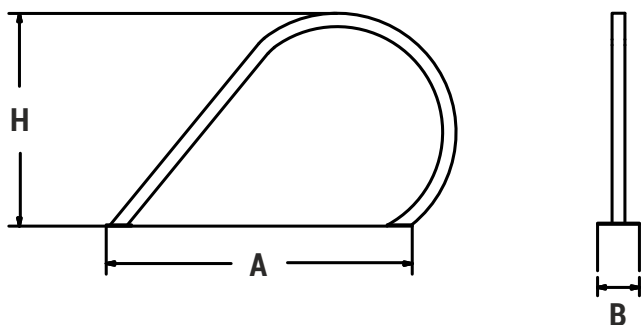

Κωδικός Προϊόντος | Product Code: K6

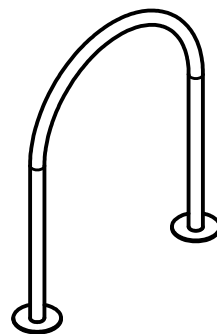

Γενικές Διαστάσεις
General Dimensions

A	B	H
1000	60.3	1000

*διαστάσεις σε mm *dimensions in mm

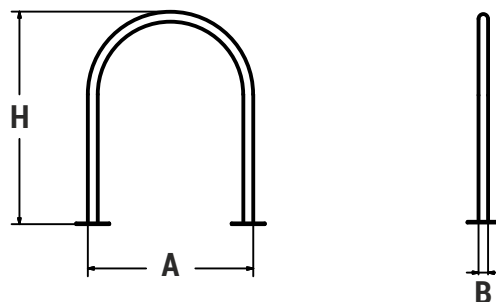

Κωδικός Προϊόντος | Product Code: K64



Γενικές Διαστάσεις
General Dimensions

A	B	H
850	60	800

*διαστάσεις σε mm *dimensions in mm

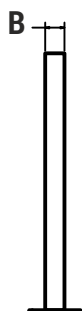
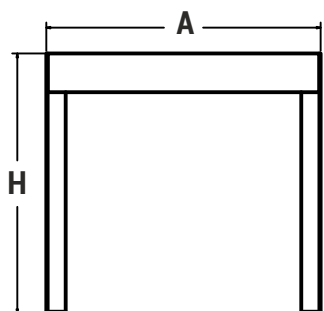
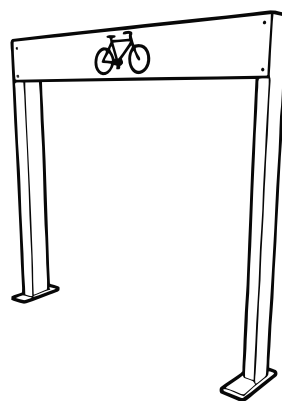

Κωδικός Προϊόντος | Product Code: K56



Γενικές Διαστάσεις
General Dimensions

A	B	H
135	170	750

*διαστάσεις σε mm *dimensions in mm

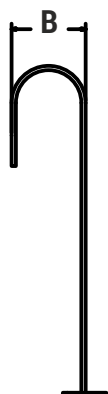
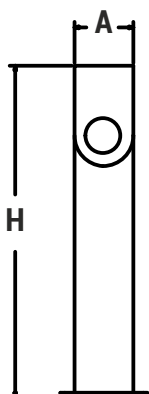
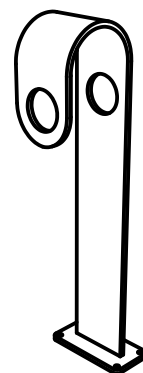

Κωδικός Προϊόντος | Product Code: K19



Γενικές Διαστάσεις
General Dimensions

A	B	H
2400	680	400

*διαστάσεις σε mm *dimensions in mm

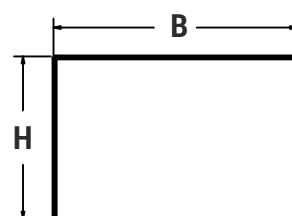
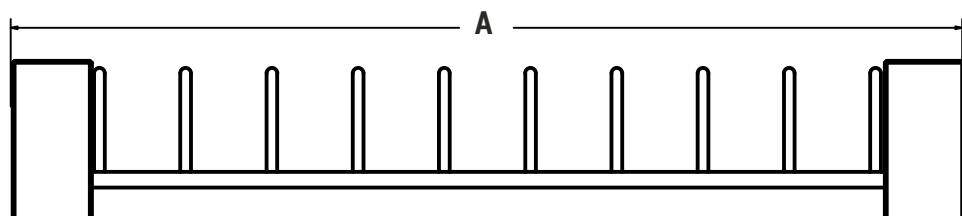
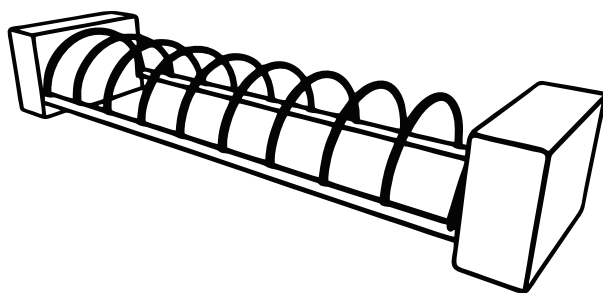

Κωδικός Προϊόντος | Product Code: K25

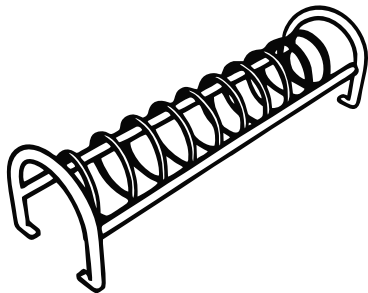

Γενικές Διαστάσεις
General Dimensions

A	B	H
2000	550	500

*διαστάσεις σε mm *dimensions in mm

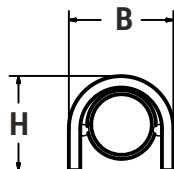
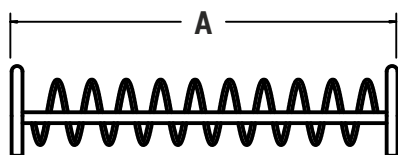

Κωδικός Προϊόντος | Product Code: K38

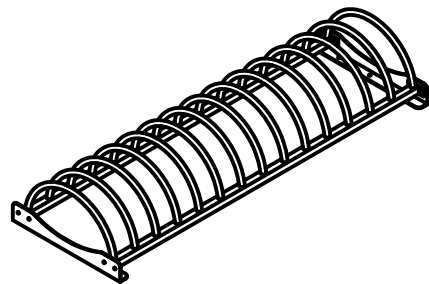

Γενικές Διαστάσεις
General Dimensions

A	B	H
2000	700	340

*διαστάσεις σε mm *dimensions in mm

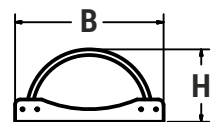
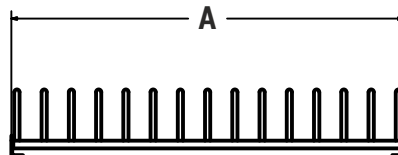

Κωδικός Προϊόντος | Product Code: K11-3

Κωδικός Προϊόντος | Product Code: K37

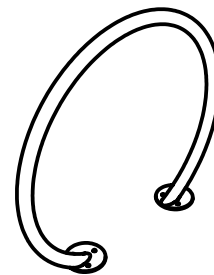
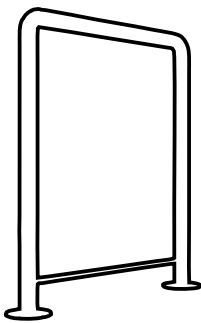

Γενικές Διαστάσεις
General Dimensions

A	B	H
850	60.3	1000

*διαστάσεις σε mm *dimensions in mm

Γενικές Διαστάσεις
General Dimensions

A	B	H
1000	50	900

*διαστάσεις σε mm *dimensions in mm

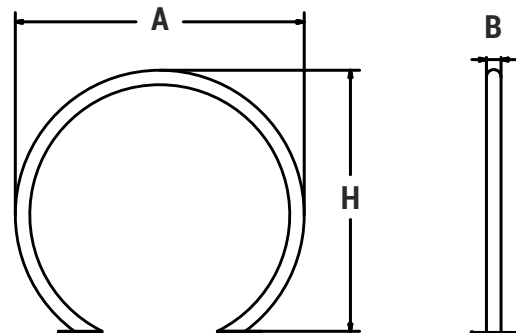
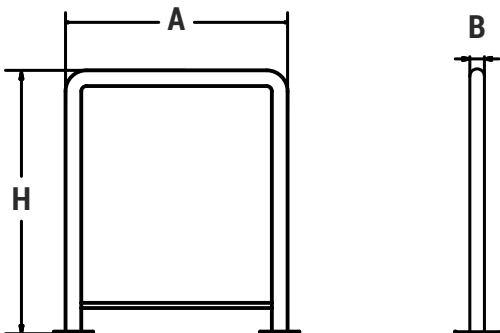

Κωδικός Προϊόντος | Product Code: K41

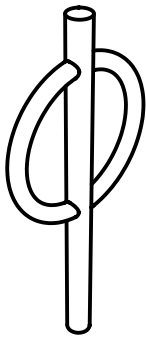

Γενικές Διαστάσεις
General Dimensions

A	B	H
400	60.3	900

*διαστάσεις σε mm *dimensions in mm

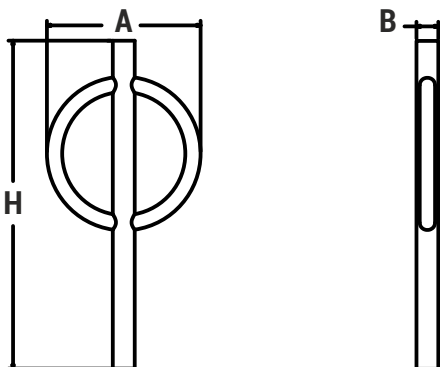

Κωδικός Προϊόντος | Product Code: K8

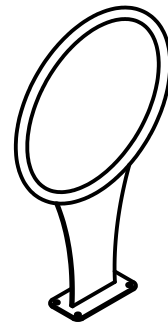

Γενικές Διαστάσεις
General Dimensions

A	B	H
500	26.9	800

*διαστάσεις σε mm *dimensions in mm

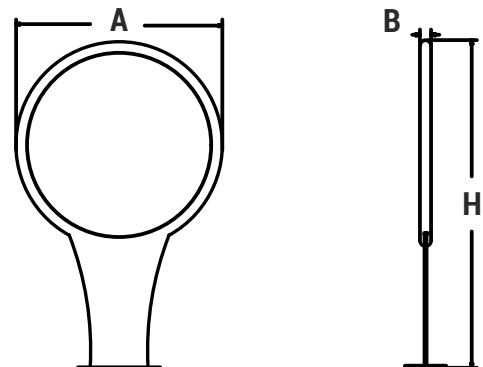

Κωδικός Προϊόντος | Product Code: K66

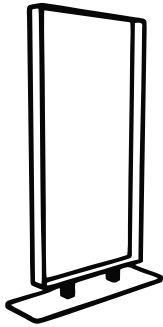

Γενικές Διαστάσεις
General Dimensions

A	B	H
350	50	750

*διαστάσεις σε mm *dimensions in mm

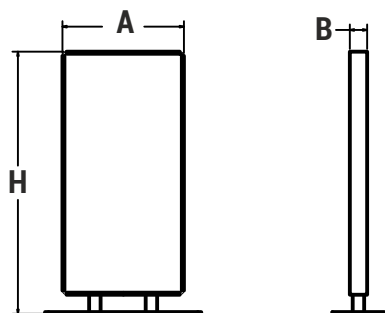

Κωδικός Προϊόντος | Product Code: K67

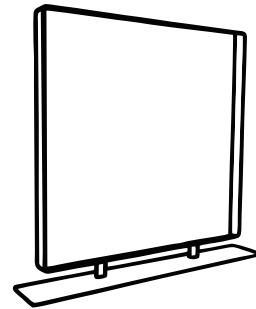

Γενικές Διαστάσεις
General Dimensions

A	B	H
700	50	750

*διαστάσεις σε mm *dimensions in mm

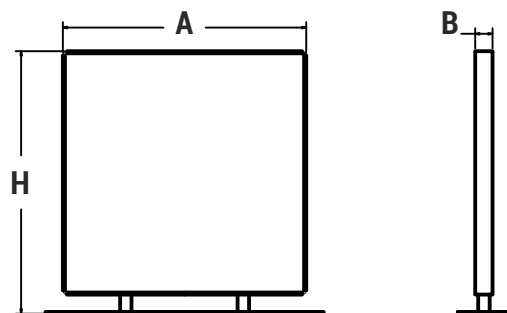

Κωδικός Προϊόντος | Product Code: K22

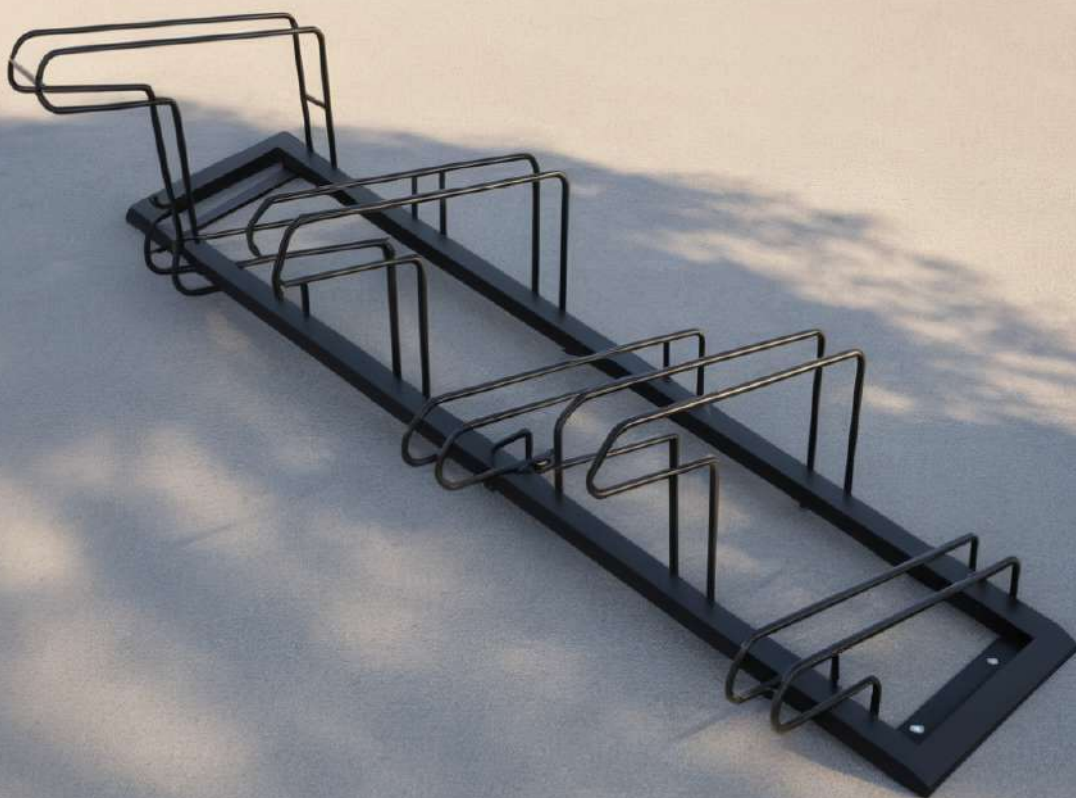

Γενικές Διαστάσεις
General Dimensions

A	B	H
1800	550	500

*διαστάσεις σε mm *dimensions in mm

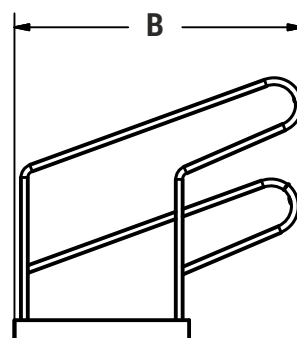
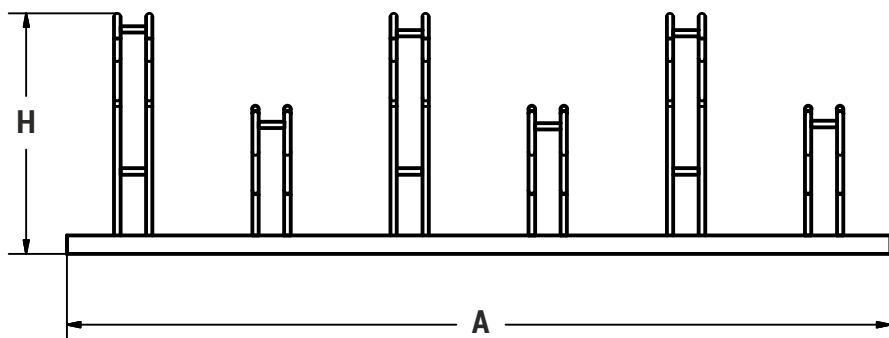
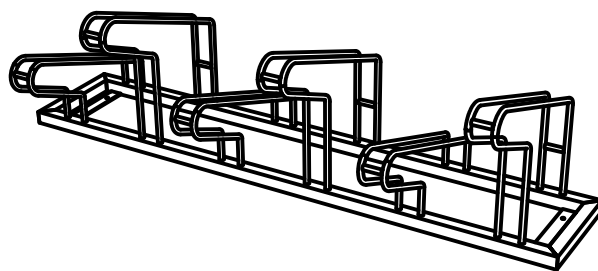

RAILINGS & BOLLARDS



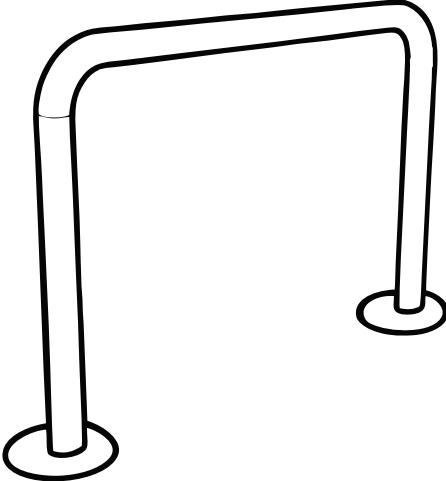

Γενικές Διαστάσεις General Dimensions	A	B	H
	1000	60.3	1000

*διαστάσεις σε mm *dimensions in mm

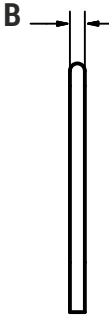
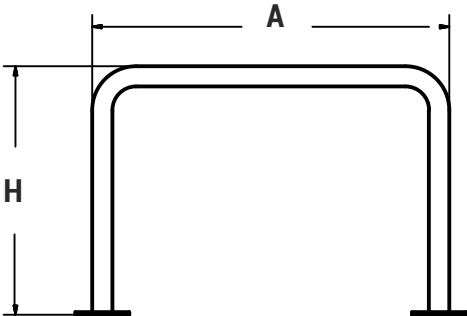

Κωδικός Προϊόντος | Product Code: MP35B

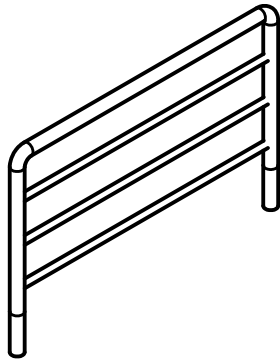

Γενικές Διαστάσεις
General Dimensions

A	B	H
1500	60	1000

*διαστάσεις σε mm *dimensions in mm

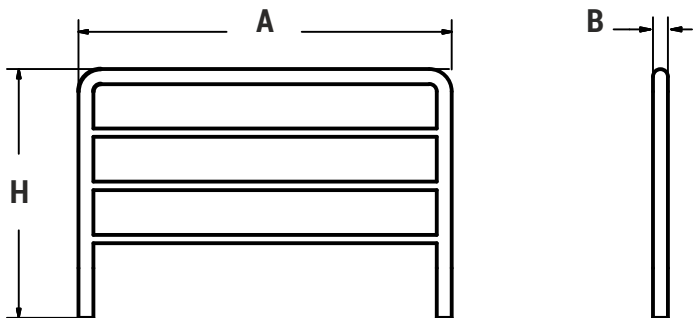

Κωδικός Προϊόντος | Product Code: MP35S

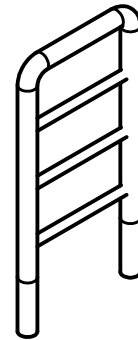

Γενικές Διαστάσεις
General Dimensions

A	B	H
500	60.3	1000

*διαστάσεις σε mm *dimensions in mm

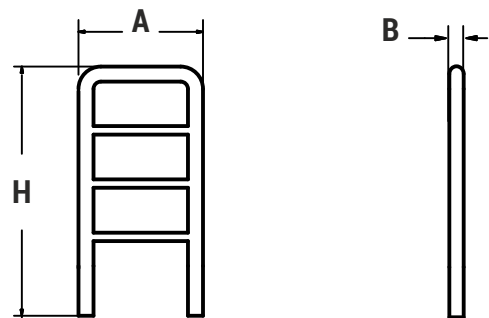

Κωδικός Προϊόντος | Product Code: MP023

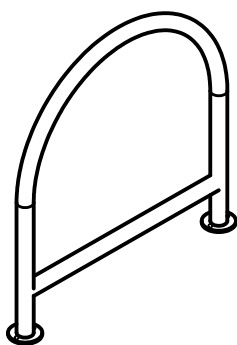

Γενικές Διαστάσεις
General Dimensions

A	B	H
800	50	870

*διαστάσεις σε mm *dimensions in mm

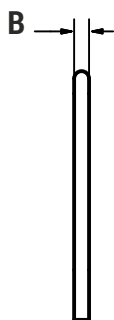
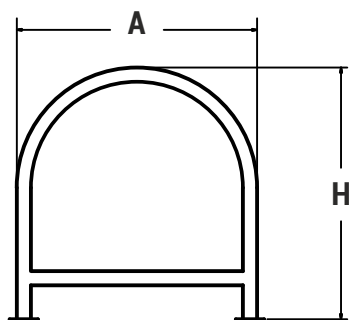

Κωδικός Προϊόντος | Product Code: MP45

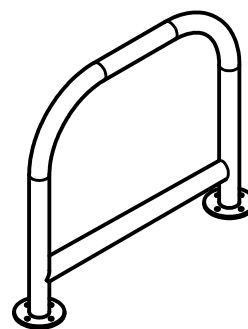

Γενικές Διαστάσεις
General Dimensions

A	B	H
800	60.3	750

*διαστάσεις σε mm *dimensions in mm

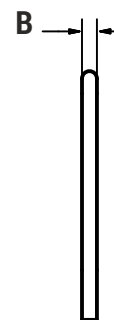
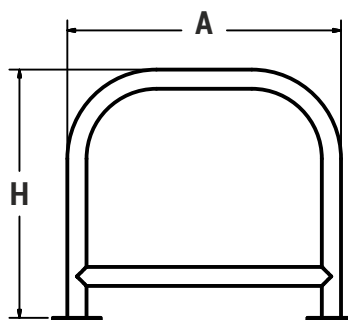

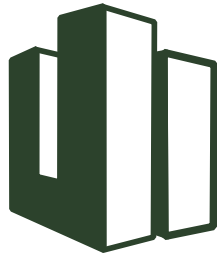

URBAN
INNOVATIONS

1ο χλμ Περιφερειακή οδού Καρδίτσας – Τρικάλων Τ.: 24410 41803, 24410 51394 Τ.Κ. 43100

1st km of the Karditsa - Trikala Ring Road Karditsa, Postal Code 43100 Tel.:+ 30 24410 41803 + 30 24410 51394

info@urban-innovations.gr